



NOXION[®]
Best in class lighting
CATALOGUE LED
2026

NOXION[®]

Best in class lighting

Illuminez vos espaces, augmentez vos possibilités

Notre marque

En 2000, Noxion Lighting s'est installé à Eindhoven aux Pays-Bas, également appelée la ville des lumières. Au cours de ces années, l'entreprise s'est consacrée à la conception (ODM), à la fabrication (OEM) et à la distribution de produits d'éclairage pour les principaux importateurs européens. En 2015, Noxion Lighting a lancé sa propre marque, offrant des solutions de haute qualité spécifiquement pour les grossistes européens en éclairage.

Notre engagement

Chez Noxion, nous aspirons à être un partenaire sur lequel vous pourrez toujours compter. L'industrie européenne de l'éclairage évolue rapidement, mettant plus que jamais l'accent sur l'efficacité énergétique. C'est pourquoi nous concevons des éclairages LED de haute qualité qui non seulement respectent les normes européennes actuelles, mais sont également prêts à relever les défis de demain. Nous voulons que nos clients puissent utiliser nos produits en toute confiance pour de nombreuses années.

En proposant des solutions d'éclairage innovantes et personnalisées à des prix compétitifs, nous nous engageons à construire des relations solides et durables avec nos clients. Avec Noxion, vous bénéficiez non seulement d'un éclairage de qualité supérieure, mais également de conseils et d'un accompagnement sur mesure pour garantir la réussite de vos projets !

Vous souhaitez participer à notre projet écologique ?

Notre engagement va bien au-delà de la simple conception d'un éclairage LED de première qualité. Nous sommes véritablement déterminés à créer un monde plus durable. Nous croyons en l'importance d'inspirer le changement en démontrant que le passage à l'éclairage LED est une solution simple mais puissante pour réduire les émissions de CO2 à l'échelle mondiale.

Nous savons que le changement se fera au fur et à mesure. C'est pourquoi, année après année, nous renouvelons notre engagement à œuvrer activement pour un avenir plus vert et plus lumineux, au bénéfice des générations futures. Ensemble, ouvrons la voie vers une planète plus saine.

www.noxion.com

À PROPOS DE NOUS

Notre objectif est de devenir le fournisseur de référence pour les luminaires et les sources lumineuses LED afin d'aider les entreprises à travers l'Europe à adopter des solutions d'éclairage écoénergétiques. Notre mission est de simplifier l'accès aux solutions durables LED pour les professionnels.

Comment la marque Noxion a-t-elle évolué au cours des 5 dernières années ?

World Wide Lighting a initialement lancé Noxion comme une alternative économique aux grandes marques établies, en offrant des performances comparables à un coût inférieur. Tout en restant abordable et de haute qualité, Noxion a progressivement affirmé sa propre identité au cours des cinq dernières années. La marque a stratégiquement recentré son activité autour des luminaires LED professionnels, s'imposant aujourd'hui comme un acteur à part entière du marché de l'éclairage professionnel.

Comment est positionné Noxion sur le marché de l'éclairage ?

Noxion est une marque d'éclairage professionnelle, conçue aux Pays-Bas et pensée pour les installateurs électriciens. Notre approche repose sur deux piliers fondamentaux : l'**efficacité de l'éclairage** et la **facilité d'installation**.

- **Qualité de production** : Nos produits sont fabriqués dans des usines reconnues, classées parmi les dix plus importantes au monde en termes de capacité, de réputation et de respect des normes éthiques en matière de travail.
- **Innovation** : Grâce à une collaboration étroite avec ces partenaires, nous intégrons des fonctionnalités avancées telles que les switch CCT et de puissance, les systèmes de commande intelligents et un rendement lumen/watt optimisés.
- **Exclusivité** : Bien que des alternatives moins chères existent sur le marché, nous refusons de compromettre la qualité. Récemment, nous avons lancé une gamme de luminaires exclusivement réservée à nos partenaires installateurs, afin de soutenir durablement leur activité.

Comment Noxion compte continuer à se développer ?

Nous conservons notre avantage concurrentiel en restant au plus près du marché et en proposant des solutions flexibles, adaptées à tous les budgets :

- **Haut de gamme** : Pour nos gammes premium telles que notre gamme de panneaux Delta Pro, nous travaillons en étroite collaboration avec des installateurs qui apprécient des fonctionnalités spécifiques, telles que les panneaux ultra-plats à éclairage latéral (sidelit), une option que nous continuons de proposer tandis que nos concurrents se concentrent exclusivement sur des modèles à éclairage arrière backlit).
- **Entrée de gamme** : Pour les gammes plus accessibles telles que Ecowhite, nous nous alignons sur les standards du e-commerce, afin de garantir un équilibre parfait entre qualité et prix.
- **Produit sur-mesure** : Nous sommes leader en termes de flexibilité. Nos nouvelles gammes proposent de multiples choix de drivers, différents types de câbles/connecteurs et accessoires (capuchons ignifugés, réflecteurs personnalisés...) qui sont assemblés dans nos entrepôts à la demande.

Nous savons que les véritables experts sont ceux qui effectuent les travaux d'installation. C'est pourquoi, nous apportons beaucoup d'importance à votre expertise et vous invitons à nous contacter directement pour nous faire part de vos idées d'amélioration. Nous sommes à votre écoute afin de pouvoir créer des produits qui vous conviennent encore mieux.

Martijn BROUNS
CMO
Noxion & WWL



LA GAMME DE PRODUITS NOXION

Chez Noxion, nous sommes concentrés sur la création de luminaires, de sources lumineuses et d'accessoires LED durables et de haute qualité. L'innovation est au cœur de tout ce que nous faisons, ce qui nous permet d'atteindre et de même dépasser les normes de l'industrie tout en assurant une performance durable et la satisfaction du client. En comprenant vos besoins uniques, nous vous offrons un soutien personnalisé, des services fiables et du matériel spécialisé pour vous accompagner lors de vos projets d'éclairage.



Innovant

La conception des produits est continuellement mise à jour pour répondre aux dernières évolutions, garantissant ainsi des solutions modernes et faciles à installer.



Ajustable

Nos dernières nouveautés sont des interrupteurs qui vous permettent de régler la puissance et/ou de la température de la lumière avec précision.



Durable

Nos produits sont très efficaces sur le plan énergétique. Les composants sont identiques que ceux utilisés pour les autres marques connues.



Noxion, Best in class lighting

Notre mission est d'offrir une gamme complète de produits d'éclairage LED, vous permettant d'installer des solutions LED de qualité dans diverses applications. Ces produits contribuent à garantir des marges rentables dans vos projets.



Nos contacts



 www.noxion.com

 +31 (0)85 - 303 29 82

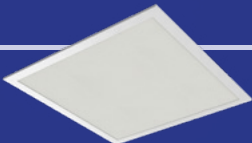
 info@noxion.com

SOMMAIRE

01		Panneaux LED	P.08
02		Réglettes LED	P.16
03		Éclairages linéaires LED	P.24
04		Highbays LED	P.32
05		Projecteurs LED	P.36
06		Éclairages publics LED	P.42
07		Hublots LED	P.46
08		Rubans LED	P.50
09		Downlights LED	P.54

10		Éclairages d'urgence	P.64
11		Spots sur rails LED	P.70
12		Spots LED	P.76
13		Ampoules LED spots	P.82
14		Ampoules LED	P.90
15		Ampoules LED à décharge	P.98
16		Ampoules LED CFL	P.102
17		Ampoules LED capsules	P.108
18		Tubes LED	P.112
19		Accessoires LED	P.120



PANNEAUX LED



BEST



**Delta Pro
V5.1 & V5**



**Delta Value
V5.1 & V5**



**Delta Pro Highlum
V5.1 & V5**



**Ecowhite
V4.0**

UGR	<19	<19 / <22	<19 / <22	<19 / <22
PUISSANCE	28W	28W	36W	13W - 64W
LUMEN	3700 - 3920	3700 - 3920	4860 - 5040	1200 - 7680
LM/W	140	140	140	121
DRIVERS	Philips	Philips	Philips	Noxion Philips
DIMMABLE	DALI / TRIAC	DALI / TRIAC	✗	✗
SWITCH	✗	CCT	CCT	CCT
DURÉE DE VIE L70	100,000h	90,000h	100,000h	70,000h
GARANTIE	6 ans	6 ans	6 ans	4 ans
QUALITÉ / PRIX	Excellent	Tres Bon	Tres Bon	Bon
DISTINCTION	Sidelit Longue durée de vie	Backlit Switch CCT	Backlit Longue durée de vie	Switch CCT

01 PANNEAUX LED

Panneau LED Delta Pro V5

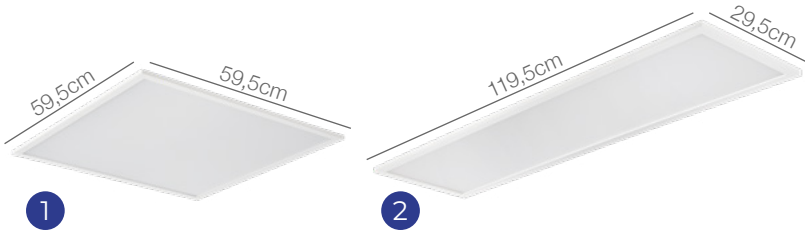

Version Sidelit disponible · Connexion rapide · Options disponibles : DALI/TRIAC · Lentille microprismatique et sans scintillement · Câbles sécurité inclus · Philips Certadrive · 3000K, 4000K · IRC80 · 2 tailles disponibles (60x60, 30x120) · Garantie 6 ans · UGR<19 · SDCM<3 · IP20 · IK02 · Class II · FP>0,95 · ACIER / AL / PS / PC · Température d'utilisation -20~40°C · CE / RoHS / ENEC / DEKRA MARK



	Pro Sidelit V5.1 UGR<19	Standard	DALI	TRIAC	W	LM	LM/W	K				
1	28W 3700LM 3000K 60x60cm	252939	255299	255288	28	3700	132	3000	90°	100,000	595x595x10	
	28W 3920LM 4000K 60x60cm	252940	255300	255291	28	3920	140	4000				
2	28W 3700LM 3000K 30x120cm	252941	255301	255292	28	3700	132	3000	90°	100,000	295x1195x10	
	28W 3920LM 4000K 30x120cm	252942	255302	255293	28	3920	140	4000				

Plus de détails

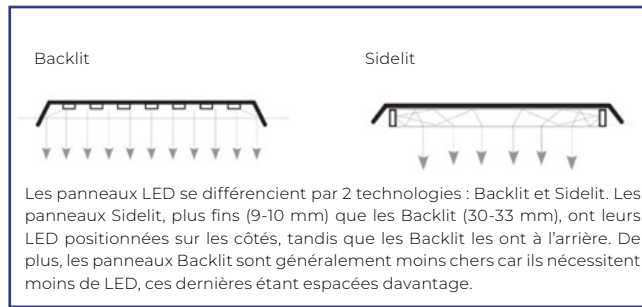

01 PANNEAUX LED

Panneau LED Delta Value V5



Version Backlit disponible · Connexion rapide · Option disponible : DALI/TRIAC · Lentille microprismatique et sans scintillement · Câbles sécurité inclus · Philips Certadrive · 2CCT switch (3000K, 4000K) · IRC80 · 3 tailles disponibles (60x60, 62x62, 30x120) · Garantie 6 ans · UGR<22 ou UGR<19 · SDCM<3 · IP20 · IK02 · Class II · FP>0,95 · ACIER / AL / PS / PC · Température d'utilisation -20~40°C · CE / RoHS / ENEC / KEMA KEUR



	#	W	LM	LM/W	K	Beam	Life	Temp
Value Backlit V5.1 UGR<19								
	Standard	DALI	TRIAC					
1	28W 2CCT 60x60cm	252933	255295	255285	28	3780/3920	135/140	3000/4000
2	28W 2CCT 62x62cm	252934			28	3780/3920	135/140	3000/4000
3	28W 2CCT 30x120cm	252936	255298	255287	28	3780/3920	135/140	3000/4000
Value Backlit V5.1 UGR<22								
1	28W 2CCT 60x60cm	252932		255284	28	3780/3920	135/140	3000/4000
2	28W 2CCT 62x62cm		255296	255286	28	3780/3920	135/140	3000/4000
3	28W 2CCT 30x120cm	252935	255297	255289	28	3780/3920	135/140	3000/4000

Plus de détails

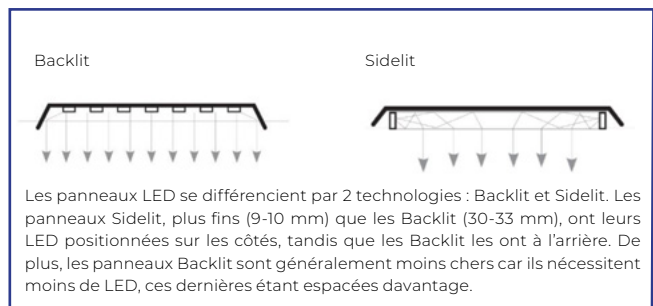
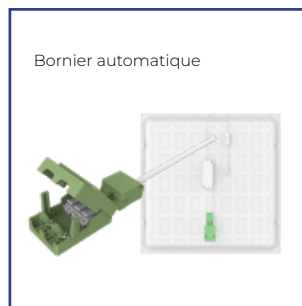
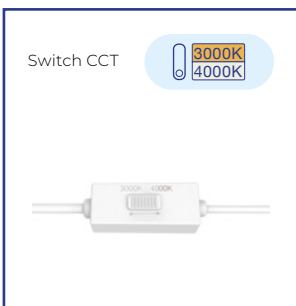

01 PANNEAUX LED

Panneau LED Delta Pro Highlum V5

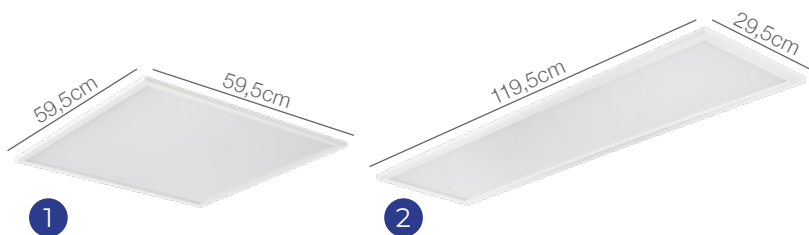

Version Backlit · Connexion rapide · Lentille microprismatique et sans scintillement · Câbles sécurité inclus · Philips Certradrive · 2CCT switch (3000K, 4000K) · IRC80 · 2 tailles disponibles (60x60, 30x120) · Garantie 6 ans · UGR<22 ou UGR<19 · SDCM<3 · IP20 · IK02 · Class II · FP>0,95 · ACIER / AL / PS / PC · Température d'utilisation -20~40°C · CE / RoHS / ENEC / DEKRA MARK



	Pro Highlum Backlit UGR<19	Standard	W	LM	LM/W	K				
1	36W 2CCT 60x60cm	252937	36	4860/ 5040	135/ 140	3000/ 4000	×	90°	100,000	595x595x32
2	36W 2CCT 30x120cm	252938	36	4860/ 5040	135/ 140	3000/ 4000		90°	100,000	295x1195x32

Plus de détails

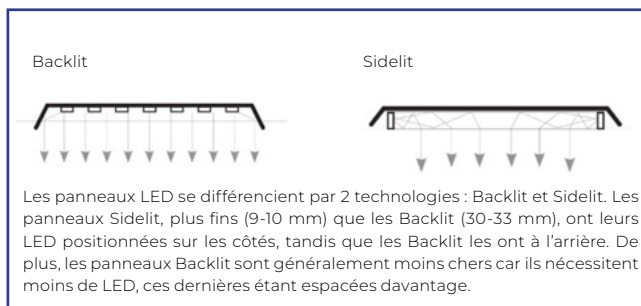
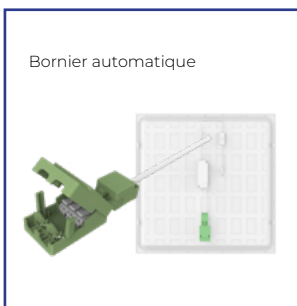

01 PANNEAUX LED

Panneau LED Ecowhite V4



Backlit · Lentille microprismatique · Driver Philips ou driver Noxion disponibles · 3000K, 4000K, 6500K ou 3CCT (3000K, 4000K, 6500K) · IRC80 · 6 tailles disponibles (60x60, 62x62, 30x120, 30x30, 30x60, 60x120) · Garantie 4 ans · UGR<22 ou UGR<19 · SDCM<6 · IP20 · IK02 · Class II · PF>0,9 · Aluminium / Fer · Température d'utilisation -20~40°C · CE / RoHS / ENEC



	UGR	#	W	LM	LM/W	K				
UGR<19										
Driver Philips										
1	28W 3200LM 3000K 60x60cm	248929	28	3200	114	3000	×	90°	70,000	595x595x34
		248931	28	3400	121	4000		90°	70,000	595x595x34
2	28W 3400LM 4000K 62x62cm	248933	28	3400	121	4000		90°	70,000	620x620x34
		248934	28	3200	114	3000		90°	70,000	1195x295x25
3	28W 3400LM 4000K 30x120cm	248936	28	3400	121	4000		90°	70,000	1195x295x25
UGR<22										
Driver Philips										
1	28W 3200LM 3000K 60x60cm	248928	28	3200	114	3000	×	120°	70,000	595x595x34
		248930	28	3400	121	4000		120°	70,000	595x595x34
		248932	28	3400	121	6500		120°	70,000	595x595x34
3	28W 3400LM 4000K 30x120cm	248935	28	3400	121	4000		120°	70,000	1195x295x34
CCT UGR<19										
Driver Philips										
1	28W 3CCT 60x60cm	250399	28	2800/3360/3000	100/120/107	3000/4000/6500	×	90°	70,000	595x595x34
2	28W 3CCT 62x62cm	250401	28	2800/3360/3000	100/120/107	3000/4000/6500		90°	70,000	620x620x34
3	28W 3CCT 30x120cm	250403	28	2800/3360/3000	100/120/107	3000/4000/6500		90°	70,000	1195x295x34
CCT UGR<22										
Driver Philips Driver Noxion 3H										
-	13W 3CCT 30x30cm	250404	13	1200/1560/1300	92/120/100	3000/4000/6500	×	120°	70,000	295x295x34
-	20W 3CCT 30x60cm	250405	20	2000/2400/2100	100/120/105	3000/4000/6500		120°	70,000	595x295x34
1	28W 3CCT 60x60cm	250398	249157	2800/3360/3000	100/120/107	3000/4000/6500		120°	70,000	595x595x34
2	28W 3CCT 62x62cm	248939	249159	2800/3360/3000	100/120/107	3000/4000/6500		120°	70,000	620x620x34
3	28W 3CCT 30x120cm	248941	250402	2800/3360/3000	100/120/107	3000/4000/6500		120°	70,000	1195x295x34
-	64W 3CCT 60x120cm	250406	64	7000/7680/7500	109/115/117	3000/4000/6500		120°	70,000	1195x595x34

Plus de détails

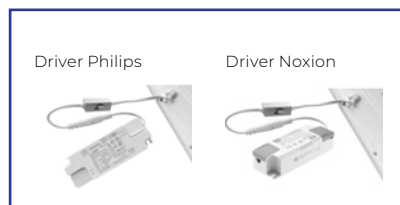

01 PANNEAUX LED

Panneau LED accessoires



		#	
		Delta Pro & Value V5.1 & V5	Ecowhite V4
1	Driver Osram DALI 42/220-240/1050 CS 0.7-1.05A (DIP) 15-42V incl. DC Cable Set at 700mA	249399	/
2	Panneau LED Noxion Clips de montage	236959	236959
3	Panneau LED Noxion Kit de Suspension	236958	236958
4	Filin de sécurité 1,5m	/	236960
5	Panneau LED Noxion Kit de montage surface 60x60cm	238301	238301
5	Panneau LED Noxion Kit de montage surface 62x62cm	250795	250795
6	Panneau LED Noxion Kit de montage surface 30x120cm	238302	238302
5	Panneau LED Noxion Kit de montage surface 30x30cm	/	250796
7	Panneau LED Noxion Kit de montage surface 30x60cm	/	250797
7	Panneau LED Noxion Kit de montage surface 60x120cm	/	249169





RÉGLETTES LED



BEST



Poseidon V3



Ecowhite V3



**Poseidon V2
(Boîtier)**



T5 Batline V2



**Réglette T8
click V2**

	Poseidon V3	Ecowhite V3	Poseidon V2 (Boîtier)	T5 Batline V2	Réglette T8 click V2
PUISSANCE	10W - 65W	20W - 50W	-	4W - 19W	-
LUMEN	1300 - 9100	2400 - 6500	-	480 - 2500	-
LM/W	140	130	-	140	-
IP & IK	IP65 / IK10	IP65 / IK10	IP65 / IK08	IP20 / IK03	IP20 / -
DRIVERS	Tridonic	Noxion	-	-	-
OPTIONS	DALI Urgence & détecteur	×	-	×	-
SWITCH	CCT & Puissance	CCT & Puissance	-	CCT	-
DURÉE DE VIE L70	80,000h	50,000h	-	25,000h	-
GARANTIE	6 ans	4 ans	4 ans	4 ans	4 ans
QUALITÉ / PRIX	Excellent	Très bon	Bon	Très bon	Très bon
DISTINCTION	Switch CCT/Puissance Câblage traversant	Switch CCT/Puissance Câblage traversant	Pour tubes LED T8	Switch CCT Switch On/Off	Pour tubes LED T8

02 RÉGLETTES LED



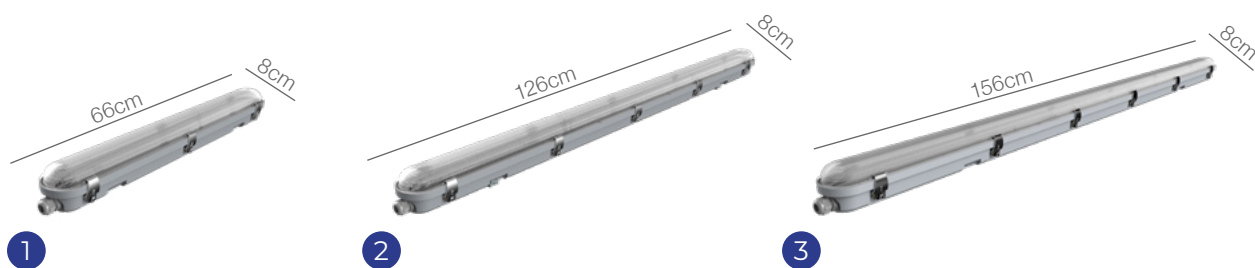







Réglette LED Étanche Poseidon V3



Câblage-traversant · Options disponibles : DALI/secours/urgence · Switch de puissance · Switch 3CCT (3000K, 4000K, 6500K) · Tailles : 60/120/150cm · Garantie 6 ans · 130° · IP65 · IK10 · Class I · Polycarbonate · Température d'utilisation -20~40°C · CE / RoHS / ENEC/ KEMA-KEUR



Poseidon V3 | CCT Standard   

1	10/12/15/18W 3CCT 60cm	247473		10	1300/1400/1400	118/127/127	3000/4000/6500	X	130°	80,000	660x80x75
				12	1560/1680/1680	120/130/130	3000/4000/6500				
				15	1950/2100/2100	130/140/140	3000/4000/6500				
				18	2340/2520/2520	130/140/140	3000/4000/6500				
2	18/21/26/30W 3CCT 120cm	247474		18	2340/2520/2520	130/140/140	3000/4000/6500	X	130°	80,000	1260x80x75
				21	2730/2940/2940	130/140/140	3000/4000/6500				
				26	3380/3640/3640	130/140/140	3000/4000/6500				
				30	3900/4200/4200	130/140/140	3000/4000/6500				
3	19/23/27/32W 3CCT 150cm	248406		19	2340/2520/2520	123/133/133	3000/4000/6500	X	130°	80,000	1560x80x75
				23	2730/2940/2940	119/128/128	3000/4000/6500				
				27	3380/3640/3640	125/135/135	3000/4000/6500				
				32	3900/4200/4200	122/131/131	3000/4000/6500				
3	35/43/55/65W 3CCT 150cm	247475	247476	35	4550/4900/4900	130/140/140	3000/4000/6500	X	130°	80,000	1560x80x75
				43	5590/6020/6020	130/140/140	3000/4000/6500				
				55	7150/7700/7700	130/140/140	3000/4000/6500				
				65	8450/9100/9100	130/140/140	3000/4000/6500				
2	30W 3CCT 120cm	248407	248408	30	3900/4200/4200	130/140/140	3000/4000/6500		130°	80,000	1260x80x75
3	43W 3CCT 150cm		248409	43	5590/6020/6020	130/140/140	3000/4000/6500		130°	80,000	1560x80x75
	65W 3CCT 150cm	247478	247477	65	8450/9100/9100	130/133/133	3000/4000/6500		130°	80,000	1560x80x75
Poseidon V3 multiple options  +   + 											
2	30W 3CCT 120cm	255402	251672	30	3900/4200/4200	130/140/140	3000/4000/6500		130°	80,000	1260x80x75
Poseidon V3 Couleur unique  + 											
3	43W 6000LM 4000K 150cm	249629		43	6000	140	4000	X	130°	80,000	1560x80x75
	65W 9000LM 4000K 150cm	249630		65	9100	140	4000	X	130°	80,000	1560x80x75
Accessoires											
Clips en acier inoxydable			240965								
Accroche de montage en surface (2 pièces)			248876								
Détecteur de mouvement et de lumière du jour Haisen HD011S			249065								



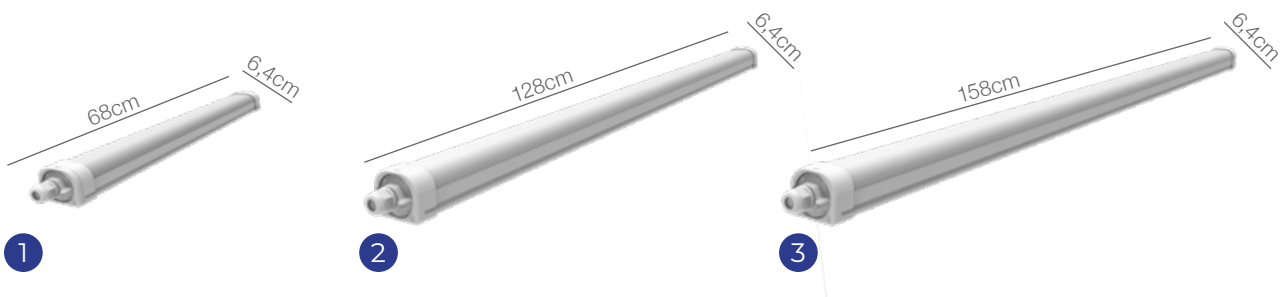

02 RÉGLETTES LED

Réglette LED Étanche Ecowhite V3



Câblage-traversant, installation facile · Switch de puissance · Switch 3CCT (3000K, 4000K, 6500K) · Tailles : 60/120/150cm
 · Garantie 4 ans · 120° · IP65 · IK10 · Class II · Aluminium / Polycarbonate · Température d'utilisation -20~40°C · CE / RoHS



	#	W	LM	LM/W	K					
1	20W 3CCT 60cm	247463	20	2400/2600/2600	119/130/130	3000/4000/6500	X	120°	50,000	680x64x57
2	24/36W 3CCT 120cm	247464	24	2900/3120/3120	119/130/130	3000/4000/6500		120°	50,000	1280x64x57
			36	4300/4680/4680	119/130/130	3000/4000/6500		120°	50,000	1580x64x57
3	36/50W 3CCT 150cm	247465	36	4300/4680/4680	119/130/130	3000/4000/6500		120°	50,000	1580x64x57
			50	6000/6500/6500	119/130/130	3000/4000/6500		120°	50,000	1580x64x57

Plus de détails

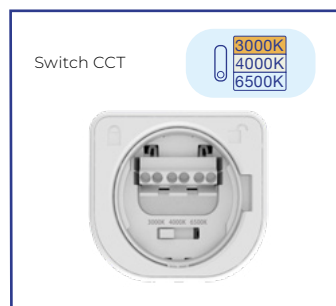
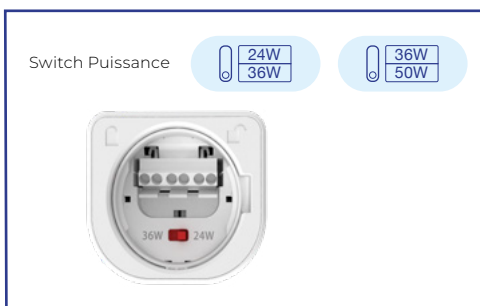

02 RÉGLETTES LED

Réglette Nue LED Étanche Poseidon V2

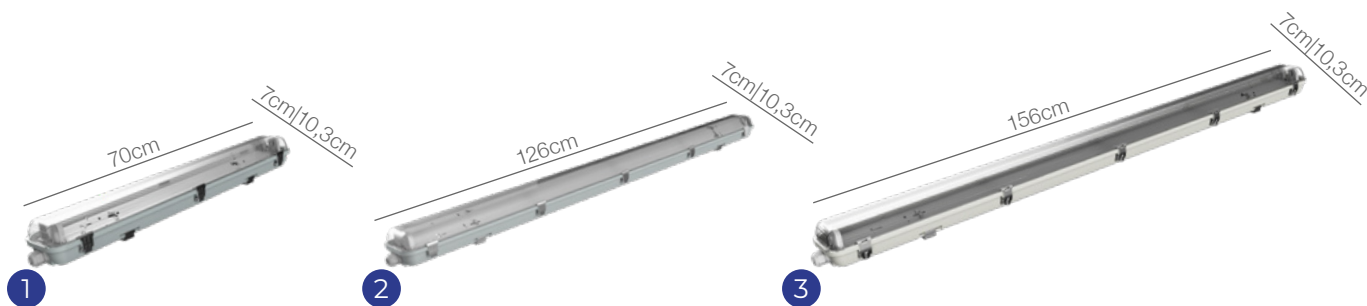

Convient pour tubes LED T8 EM ou UN · Alimentation 230V · Tailles : 60/120/150cm · Garantie 4 ans · IP65 · IK08 · Class II · Polycarbonate · Température d'utilisation -20~40°C · CE / RoHS



	Boîtier Poseidon V2 + Tubes LED	#			W	LM	LM/W	×	50,000	660x70x68
		3000K	4000K	6500K						
1	60cm (Simple) + 1 tube 9W 900LM	246780	246786	246792	9	900	100	×	50,000	660x70x68
	60cm (Double) + 2 tubes 9W 2x900LM	246781	246787	246793	2x9	1800	100		50,000	660x103x68
2	120cm (Simple) + 1 tube 17,5W 1800LM	246782	246788	246794	17,5	1800	103		50,000	1260x70x68
	120cm (Double) + 2 tubes 17,5W 2x1800LM	246784	246789	246795	2x17,5	3600	103		50,000	1260x103x68
3	150cm (Simple) + 1 tube 22W 2300LM	246783	246790	246796	22	2300	105		50,000	1560x70x68
	150cm (Double) + 2 tubes 22W 2x2300LM	246785	246791	246797	2x22	4600	105		50,000	1560x103x68
Boîtier Poseidon V2 (sans Tubes LED)										
1	60cm (Simple)	237531								660x70x68
	60cm (Double)	237532								660x103x68
2	120cm (Simple)	237533								1260x70x68
	120cm (Double)	237534								1260x103x68
3	150cm (Simple)	237535								1560x70x68
	150cm (Double)	237536								1560x103x68

Plus de détails







02 RÉGLETTES LED

Réglette LED T5 Batline V2



Switch on/off · Possibilité de ligne continue (4/8/11W max 20 pcs, 15/19W max 12 pcs) · Raccordement par prise · Switch 3CCT (3000K, 4000K, 6500K) · Tailles : 30/60/90/120/150cm · Garantie 4 ans · 120° · IP20 · IK03 · Class II · Polycarbonate · Température d'utilisation -20~40°C · CE / RoHS



#	W	LM	LM/W	K					
4W 3CCT 30cm	247468	4	480/530/520	120/133/130	3000/4000/6500	X	120°	25,000	288x22x57
8W 3CCT 60cm	247469	8	990/1080/1050	120/138/131	3000/4000/6500		120°	25,000	550x22x35
11W 3CCT 90cm	247470	11	1340/1420/1440	122/139/131	3000/4000/6500		120°	25,000	850x22x35
15W 3CCT 120cm	247471	15	1855/2020/1980	124/138/132	3000/4000/6500		120°	25,000	1150x22x35
19W 3CCT 150cm	247472	19	2370/2580/2500	125/140/132	3000/4000/6500		120°	25,000	1450x22x35

Plus de détails

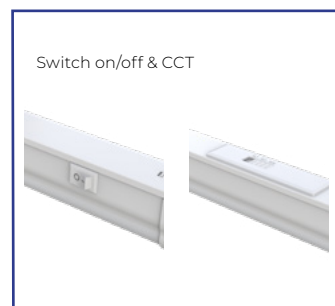

02 RÉGLETTES LED

Réglette LED T8 Click / Réflecteur V2

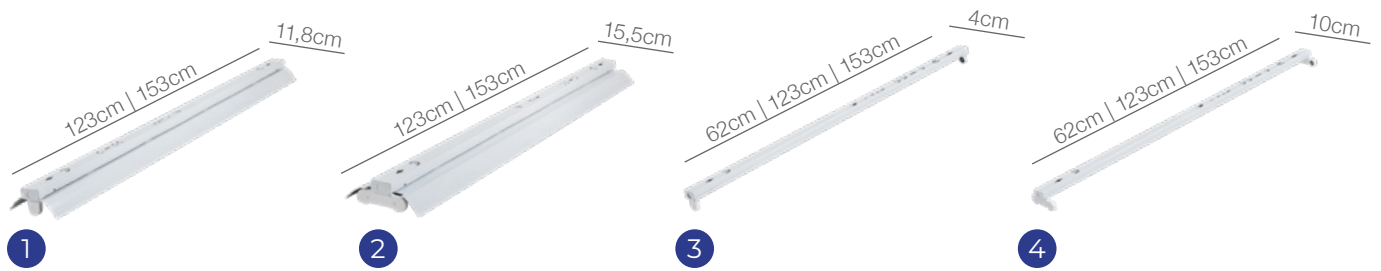

Convient pour tubes LED T8 EM ou UN · Disponible avec réflecteur · Alimentation 230V · Sans risque pour l'installation L/N des deux côtés · Tailles : 60/120/150cm · Garantie 4 ans · IP20 · IK02 · Class I · Acier · Température d'utilisation -20~40°C · CE

🔍 Tubes T8 disponibles page 104



Avec réflecteur		Sans réflecteur			
1	1x36W 120cm	249482	×	1230x118x57	
	1x58W 150cm	249483		1530x118x57	
2	2x36W 120cm	249484		1230x155x55	
	2x58W 150cm	249485		1530x155x55	
3	1x18W 60cm	249476		×	620x40x57
	1x36W 120cm	249477			1230x40x57
	1x58W 150cm	249478	1530x40x57		
4	2x18W 60cm	249479	620x100x52		
	2x36W 120cm	249480	1230x100x52		
	2x58W 150cm	249481	1530x100x52		

Plus de détails

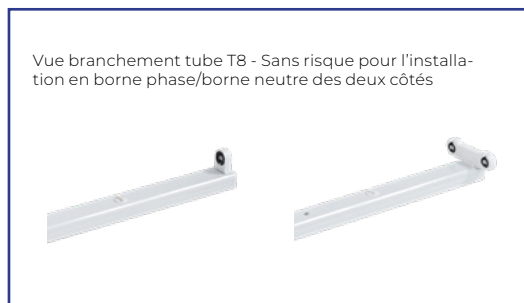
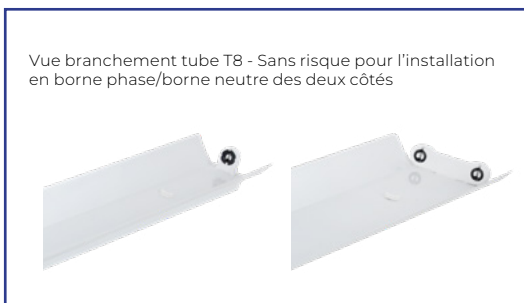





ÉCLAIRAGES LINÉAIRES LED



BEST



Easy Trunk



NX-Line V3 & V2



Retrofit

	Easy Trunk	NX-Line V3 & V2	Retrofit
PUISSANCE	60W	35W - 70W	32W - 55W
LUMEN	9000	6300 - 13650	12025
LM/W	150	180 - 195	170
IP / IK	IP40 / IK06	IP20 / IK04	IP20 / IK10
OPTIONS	0-10V & Urgence	DALI & Urgence	Urgence
SWITCH	✗	Puissance	Puissance
DURÉE DE VIE L70	72,000h	70,000h - 50,000h	50,000h
GARANTIE	6 ans	6 ans	5 ans
QUALITÉ / PRIX	Très bon	Excellent	Bon
DISTINCTION	S'adapte à de nombreuses marques	Switch Puissance Plusieurs angles de diffusion	Switch Puissance Fixations réglables

03 ÉCLAIRAGES LINÉAIRES LED

Éclairage Linéaire Easy Trunk

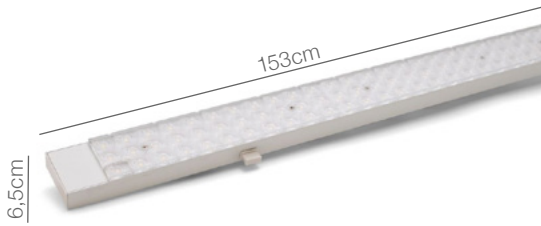

Remplacement facile de l'installation existante (voir liste des fabricants) · Options disponibles : DALI/0-10V/urgence · Garantie 6 ans · Angle 30°/60°/90°/120° · IP40 · IK06 · Class I · FP>0,9 · Aluminium

<div style="display: flex; justify-content: space-between; align-items: center;"> <div style="display: flex; gap: 10px;"> # W LM LM/W K ⌚ ⌂ ⌚ 🏠 </div> <div style="display: flex; gap: 10px;"> 🌡️ -10~45°C IK06 IP40 CRI80 6 </div> </div>											
Easy Trunk - NLS	Standard			W	LM	LM/W	K	⌚	⌂	⌚	🏠
Easy Trunk - NLS-R58-840-90°	244235			60	9000	150	4000	✕	90°	72,000	1530x65x30
Easy Trunk - NLS-R58-850-90°	236982			60	9000	150	5000		90°	72,000	1530x65x30
Easy Trunk - RIDI											
Easy Trunk - RIDI VLG-T8-850-90°	236991			60	9000	150	5000	✕	90°	72,000	1530x65x30
Easy Trunk - RIDI VLG-T8-850-120°	248654 248653			60	9000	150	5000		120°	72,000	1530x65x30
Easy Trunk - SITECO											
Easy Trunk - Siteco-mod-850-90°	237000			60	9000	150	5000	✕	90°	72,000	1530x65x30
Easy Trunk - AEG											
Easy Trunk - AEG GLX TS-865-90°	248637 248638			60	9000	150	6500	✕	90°	72,000	1530x65x30
Easy Trunk - TTX											
Easy Trunk - TTX400-T5-840-90°	238452			60	9000	150	4000	✕	90°	72,000	160x20x20
Easy Trunk - TTX400-T8-840-90°	238439			60	9000	150	4000		90°	72,000	160x20x20
Easy Trunk - TTX400-T8-850-30°	243398			60	9000	150	5000		30°	72,000	160x20x20
Easy Trunk - TTX400-T8-850-90°	237012 237013			60	9000	150	5000		90°	72,000	160x20x20
EasyTrunk - TTX200-58W-840-90°	237527			60	9000	150	4000		90°	72,000	160x20x20
Easy Trunk - TTX200-58W-850-90°	237007			60	9000	150	5000		90°	72,000	160x20x20
Easy Trunk - VEKO											
Easy Trunk - VEKO PNR NEW-840-120°	245193			60	9000	150	4000	✕	120°	72,000	160x20x20
Easy Trunk - VEKO PNR NEW-850-90°	237021 245747 237022 247667			60	9000	150	5000		90°	72,000	160x20x20
Easy Trunk - ZUM											
Easy Trunk - ZUM tecton-850-90°	237020			60	9000	150	5000	✕	90°	72,000	160x20x20
Easy Trunk - ZUM-ZX1-850-90°	237014 237015			60	9000	150	5000		90°	72,000	160x20x20
Easy Trunk - ZUM-ZX2-T8-850-90°	237018 237019			60	9000	150	5000		90°	72,000	160x20x20
Easy Trunk - TMX204											
Easy Trunk TMX204 T8-58W-840-90°	237026 248909			60	9000	150	4000	✕	90°	72,000	160x20x20
Easy Trunk TMX204 T8-58W-840-120°	237025			60	9000	150	4000		120°	72,000	160x20x20

03 ÉCLAIRAGES LINÉAIRES LED

Éclairage Linéaire NX-Line V3 & V2



Ligne continue idéale pour les grandes surfaces · Options disponibles : DALI/urgence/détecteur/UGR<19 · Switch de puissance · 4000K · Garantie 6 ans · Angle 30°/60°/90°/120° · IP20 · IK04 · Class I · FP>0,9 · Acier / PMMA · Température d'utilisation -20~40°C

<div style="display: flex; justify-content: space-between; align-items: center;"> <div style="display: flex; gap: 10px;"> CE RoHS -20~40°C IK04 IP20 CRI80 6 </div> </div>												
<div style="display: flex; justify-content: space-between; align-items: center; background-color: #003366; color: white; padding: 5px;"> # W LM LM/W K ↻ ↕ 🕒 📏 </div>												
V2 70W												
Standard												
70W 4000K FD120 WH (PC Diffuser)	248169		70	12600	180	4000	✓	FD-120°	50,000	1500x60x40		
70W 4000K FD120 WH	248174	251849	70	12600	180	4000		FD-120°	50,000	1500x60x40		
70W 4000K SP30 WH	248175		70	12600	180	4000		SP-30°	50,000	1500x60x40		
V2 Switch 55/60/65/70W												
55/60/65/70W 4000K NR60 WH (Individual Lens Optic)	248187	248167	55/60/65/70	9900/10800/11700/12600	180	4000		NR-60°	50,000	1500x60x40		
55/60/65/70W 4000K WD90 WH (Individual Lens Optic)	248188	248168	55/60/65/70	9900/10800/11700/12600	180	4000		WD-90°	50,000	1500x60x40		
55/60/65/70W 4000K SP30 WH (Central Line Lens Optic)	248189		55/60/65/70	9900/10800/11700/12600	180	4000		SP-30°	50,000	1500x60x40		
55/60/65/70W 6500K SP30 WH (Central Line Lens Optic)	249236		55/60/65/70	9900/10800/11700/12600	180	6500		SP-30°	50,000	1500x60x40		
V3 Switch 35/40/45/50W												
35/40/45/50W 4000K WD90 WH (Central Line Lens Optic)	252820	250373	35/40/45/50	6825/7800/8775/9750	195	4000	✗	WD-90°	70,000	1500x60x40		
35/40/45/50W 4000K FD120 WH (Central Line Lens Optic)	252824	252970	35/40/45/50	6825/7800/8775/9750	195	4000		FD-120°	70,000	1500x60x40		
35/40/45/50W 4000K FD120 WH (PC Diffuser)	252822	251851	35/40/45/50	6825/7800/8775/9750	195	4000		FD-120°	70,000	1500x60x40		
V3 Switch 40/50/60/70W												
40/50/60/70W 4000K WD90 WH (Individual Lens Optic)	252826	254696	40/50/60/70	7800/9750/11700/13650	195	4000		WD-90°	70,000	1500x60x40		
40/50/60/70W 4000K NR60 WH		255941	40/50/60/70	7800/9750/11700/13650	195	4000		NR-60°	50,000	1500x60x40		
V3 Switch 55/60/65/70W												
55/60/65/70W 4000K FD120 WH (Central Line Lens Optic)	252844	250375	256105	252983	55/60/65/70	10725/11700/12675/13650	195	4000		FD-120°	70,000	1500x60x40
55/60/65/70W 4000K WD90 WH (Central Line Lens Optic)	252821	248173	252931	253253	55/60/65/70	10725/11700/12675/13650	195	4000		WD-90°	70,000	1500x60x40

Plus de détails

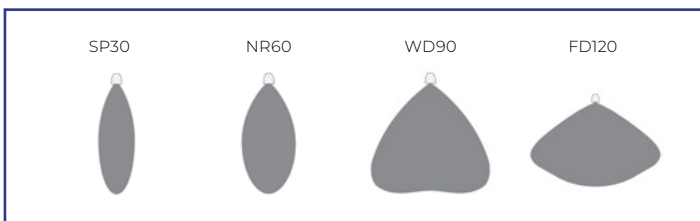

03 ÉCLAIRAGES LINÉAIRES LED

NX-Line accessoires

Rails



#

Rail 8/1500 WH	235031
Rail 8/1500 End Part WH	235032
Rail 8/3000 WH	235033
Rail 8/3000 End Part WH	235034

Kits de montage & suspensions

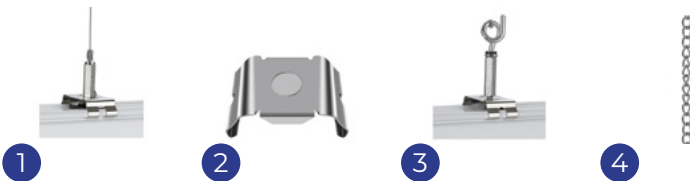

#

1	Chaîne de suspension 3M	235131
2	Clips de montage en surface des rails ø13.5mm	235137
3	Crochet de suspension (sans chaîne)	245483
4	Chaîne suspendue	248170

Couvercles & caches



#

1	Couvercle Blind Cover 1500 WH sans les caches	235135
2	Cache Blind Cover 1500 WH	235136 237520
3	Cache End Cap WH	235139
4	Cache End Cap Blind / Track Light / Sensor Cover WH	235141

Connecteurs & autres

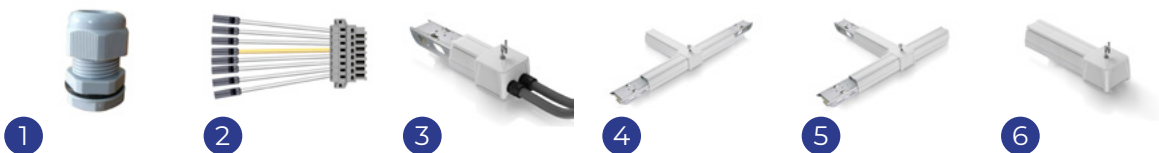

		#
1	Presse étoupe M20x1.5mm Ø7mm-14mm	235142
2	Connecteur d'alimentation 8	235144
3	Boitier d'alimentation 8 WH	235145
4	Connecteur Node T OIO 8 WH	235150
5	Connecteur Node T OOI 8 WH	235151
6	Boitier de sortie d'alimentation 8 WH	253988

Détecteurs & autres



		#
1	Couvercle pour rail NX-Line 8/1500 WH	235153
2	DALI PS	235157
3	Couvercle pour rail NX-Line avec détecteur 8/1500 WH	235154

Lentilles



	#
Lentille 300mm NR60 pour Noxion NX-Line	244324
Lentille 300mm WD90 pour Noxion NX-Line	244325
Lentille 300mm FD120 pour Noxion NX-Line	244326

03 ÉCLAIRAGES LINÉAIRES LED

Éclairage Linéaire Retrofit



Ligne continue idéale pour les grandes surfaces · Option disponible : urgence · Switch de puissance · 4000K & 5700K · Garantie 5 ans · Angle 60°/90°/120° · IP20 · IK10 · Class I · FP>0,9 · Acier / PMMA · Température d'utilisation -20~40°C



Retrofit	Standard	3H								
32/40/48/55W 4000K 60°	257850		32/40/48/55	Max 9795	170	4000	×	60°	50,000	1470x65
32/40/48/55W 5700K 60°	257849		32/40/48/55	Max 9795	170	5700		60°	50,000	1470x65
32/40/48/55W 4000K 90°	257848	257851	32/40/48/55	Max 12025	160	4000		90°	50,000	1470x65
32/40/48/55W 5700K 90°	257847		32/40/48/55	Max 12025	160	5700		90°	50,000	1470x65
32/40/48/55W 4000K 120°	257846		32/40/48/55	Max 9175	155	4000		120°	50,000	1470x65
32/40/48/55W 5700K 120°	257845		32/40/48/55	Max 9175	155	4000		120°	50,000	1470x65
Câble pour raccordement										
Câble Philips TTX200	257854									
Câble Philips TTX-400 / Philips Maxos	257853									
Câble Siemens	257859									
Câble Zumtobel ZX2	257858									
Câble Zumtobel Regiolux SMT / Regolux SPT / Veko old	257857									
Câble Zumtobel Norton / siteco DUS / Fluolite TRX	257856									
Câble Zumtobel/ Veko new PRN / Trilux new	257855									
Câble Zumtobel ZX1	257852									

Plus de détails







HIGHBAYS LED

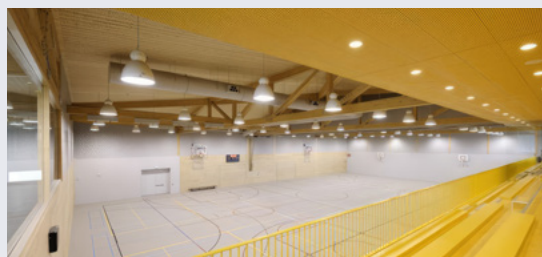

BEST



Concord V4



Ecowhite V2

PUISSANCE	100W - 200W	100W - 200W
LUMEN	17000 - 34000	16000 - 32000
LM/W	170	160
IP / IK	IP65 / IK08	IP65 / IK08
OPTIONS	DALI & 0-10V	0-10
SWITCH	CCT & Puissance	×
DURÉE DE VIE L70	140,000h	100,000h
GARANTIE	6 ans	4 ans
QUALITÉ / PRIX	Excellent	Très bon
DISTINCTION	Switch CCT & Puissance Déecteur compatible	Déecteur compatible

04 HIGHBAYS LED

Highbay LED Concord V4



Idéal pour une installation entre 4 et 14 mètres · Crochet de montage fourni · Accessoires disponibles : Détecteur, télécommande, réflecteur et support de montage · Switch de puissance 100/120/150/200W · Switch 3CCT (4000K, 5200K, 6500K) · Garantie 6 ans · 0-10V dimmable · DALI 2 (non push dim) · 90° ou 120 · IP65 · IK08 · Class I · FP>0,9 · ACD12 / PC / Aluminium · Température d'utilisation -30~50°C · CE / RoHS / ENEC



		#	W	LM	LM/W	K				
1	100/120/150/200W 3CCT 90D 0-10V	249174 252814	100/120/ 150/200	17000/20400/ 24750/33000	170/170/ 165/165	4000	✓	90°	140,000	Ø297x120
				17500/21000/ 25500/34000	170/170/ 165/165	5200				
				17000/20400/ 24750/33000	170/170/ 165/165	6500				
	100/120/150/200W 3CCT 120D 0-10V	249175 252832	100/120/ 150/200	17000/20400/ 24750/33000	170/170/ 165/165	4000		120°	140,000	Ø297x120
				17500/21000/ 25500/34000	170/170/ 165/165	5200				
	200W 4000K 60D DALI	253103	200	34000	170	4000	60°	100,000	Ø297x107	
	200W 4000K 90D DALI	249641	200	34000	170	4000	90°	100,000	Ø297x107	

Accessoires		
2	Diffuseur avec couvercle PC	249366
3	Lentille circulaire PC 60°	249367
3	Lentille circulaire PC 90°	250432
3	Lentille circulaire PC 120°	249644
4	Support de montage	249368
5	Télécommande	249369
6	Détecteur de mouvement	249370

Plus de détails

Switch Puissance & CCT

Détecteur (non dispo. pour version DALI)

Crochet ouvert (non dispo. pour version DALI)

Connecteur étanche (Incl. DALI & Puissance)

04 HIGHBAYS LED

Highbay LED Ecowhite V2



Idéal pour une installation entre 4 et 14 mètres · Crochet de montage fourni · Accessoires disponibles : Détecteur, télécommande, réflecteur et support · 100W ou 200W · 4000K · Garantie 6 ans · 0-10V dimmable · 90 ou 120° · IP65 · IK08 · Class I · FP>0,9 · Aluminium/PC · Température d'utilisation -30~50°C · CE / RoHS

<div style="display: flex; justify-content: space-between; align-items: center;"> <div style="display: flex; gap: 10px;"> CE RoHS -30~50°C IK08 IP65 CRI80 6 </div> </div>											
<div style="display: flex; justify-content: space-between; align-items: center;"> <div style="display: flex; gap: 10px;"> W LM LM/W K 0-10V 90° 120° 100,000 Ø300x152 </div> </div>											
1	100W 16000LM 4000K 90D 1-10V	249170	100	16000	160	4000	✓	90°	100,000	Ø263x150	
	100W 16000LM 4000K 120D 1-10V	249171	100	16000	160	4000		120°	100,000	Ø263x150	
	200W 32000LM 4000K 90D 1-10V	249172	200	32000	160	4000		90°	100,000	Ø300x152	
	200W 32000LM 4000K 120D 1-10V	249173	200	32000	160	4000		120°	100,000	Ø300x152	
Accessoires											
2	Diffuseur avec couvercle PC*	249366									
3	Lentille circulaire PC 60**	249367									
3	Lentille circulaire PC 120**	249644									
4	Support de montage	249368									
5	Télécommande	249369									
6	Détecteur de mouvement	249370									
		244733									

*Compatible uniquement avec les versions 200W

Plus de détails

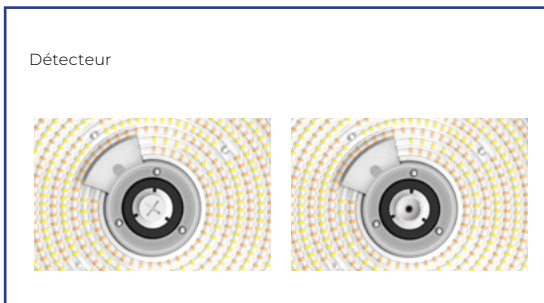



PROJECTEURS LED



Beamy G3.1



Beam V2

BEST



ProBeam V2

PUISSANCE	10W - 50W	40W - 100W	130W - 210W
LUMEN	1100 - 5500	5600 - 14000	18200 - 29400
LM/W	110	140	140
IP / IK	IP65 / IK07	IP66 / IK08	IP66 / IK08
OPTIONS	Détecteur	×	Connexion Zhaga
SWITCH	×	CCT & Puissance	CCT & Puissance
DURÉE DE VIE L70	30,000h	150,000h	150,000h
GARANTIE	4 ans	6 ans	6 ans
QUALITÉ / PRIX	Très bon	Très bon	Excellent
DISTINCTION	Détecteur PIR	Switch CCT & Puissance	Switch CCT & Puissance

05 PROJECTEURS LED

Projecteur LED Beamy G3.1



Câble de 1m pour une installation facile · Option Détecteur PIR · Le détecteur peut être retiré facilement · 10W, 20W, 30W ou 50W · 3000K ou 4000K · Garantie 4 ans · Symétrique 100°/110° · Détecteur IP44 - Projecteur IP65 · IK07 · Class I · FP>0,9 · Aluminium/Verre/PC · Température d'utilisation -20~40°C · CE / RoHS



	#	W	LM	LM/W	K					
Standard										
1	10W 1100LM 3000K Détecteur	253264	10	1100	110	3000	×	100°	30,000	90x65x28
	10W 1100LM 4000K Détecteur	253265	10	1100	110	4000		100°	30,000	90x65x28
2	20W 2200LM 3000K Détecteur	253266	20	2200	110	3000		100°	30,000	110x90x28
	20W 2200LM 4000K Détecteur	253267	20	2200	110	4000		100°	30,000	110x90x28
3	30W 3300LM 3000K Détecteur	253268	30	3300	110	3000		110°	30,000	140x120x28
	30W 3300LM 4000K Détecteur	253269	30	3300	110	4000		110°	30,000	140x120x28
4	50W 5500LM 3000K Détecteur	253270	50	5500	110	3000		110°	30,000	175x140x28
	50W 5500LM 4000K Détecteur	253271	50	5500	110	4000		110°	30,000	175x140x28
Avec Détecteur PIR										
1	10W 1100LM 3000K Détecteur PIR	253393	10	1100	110	3000	×	100°	30,000	90x135x48
	10W 1100LM 4000K Détecteur PIR	253394	10	1100	110	4000		100°	30,000	90x135x48
2	20W 2200LM 3000K Détecteur PIR	253395	20	2200	110	3000		100°	30,000	110x155x48
	20W 2200LM 4000K Détecteur PIR	253396	20	2200	110	4000		100°	30,000	110x155x48
3	30W 3300LM 3000K Détecteur PIR	253397	30	3300	110	3000		110°	30,000	140x190x48
	30W 3300LM 4000K Détecteur PIR	253398	30	3300	110	4000		110°	30,000	140x190x48
4	50W 5500LM 3000K Détecteur PIR	253399	50	5500	110	3000		110°	30,000	175x200x48
	50W 5500LM 4000K Détecteur PIR	253400	50	5500	110	4000		110°	30,000	175x200x48

Plus de détails



05 PROJECTEURS LED

Projecteur LED Beam V2



Câble de 1m pour une installation facile · Idéal pour les chantiers, les terrains de sport, les panneaux d'affichage · Switch de puissance 40/80/100W · Switch 3CCT (3000K, 4000K, 6500K) · Garantie 6 ans · Symétrique 90° et Asymétrique Type II · IP66 · IK08 · Class I · FP>0,9 · Aluminium/Verre/PC · Température d'utilisation -20~40°C · CE / RoHS



		#		W		LM		LM/W		K						
		Sym.	Asym.													
1	40/80/100W 3CCT	248954		40/80/100	5600/10400/12000	140/140/145	3000	×	90°	150,000	330x268x47.5					
					5600/11200/14000	130/140/135	4000									
					5800/10800/12500	120/140/125	6500									
2	40/80/100W 3CCT	248955		40/80/100	5300/9900/11400	133/140/138	3000	×	Type II	150,000	330x268x47.5					
					5600/11200/14000	124/140/129	4000									
					5500/10300/11900	114/140/119	6500									

Plus de détails



05 PROJECTEURS LED

Projecteur LED ProBeam V2



Branchement Zhaga · Câble de 1m pour une installation facile · Idéal pour les chantiers de construction, les terrains de sport, les panneaux d'affichage, les parkings · Switch de puissance 130/170/210W · Switch 3CCT (3000K, 4000K, 6500K) · Garantie 6 ans · Symétrique 60° et Asymétrique Type II · IP66 · IK08 · Class I · FP>0,9 · Aluminium/Verre/PC · Température d'utilisation -20~40°C · CE / RoHS



		#		W	LM	LM/W	K				
		Sym.	Asym.								
1	130/170/210W 3CCT	248956		130/170/210	17300/21000/23900	133/123/113	3000	×	60°	150,000	412x360x54
					18200/23800/29400	140/140/140	4000				
					18000/21900/25000	138/128/119	6500				
2	130/170/210W 3CCT	248957		130/170/210	18200/22100/25200	140/130/120	3000	×	Type II	150,000	412x360x54
					18200/23800/29400	140/140/140	4000				
					18900/23000/26300	145/135/125	6500				

Plus de détails







ÉCLAIRAGES PUBLICS LED



Streetlight

PUISSANCE	30W - 150W
LUMEN	3600 - 18000
LM/W	120
IP / IK	IP65 / IK06
OPTIONS	Détecteur de lumière du jour
SWITCH	×
DURÉE DE VIE L70	25,000h
GARANTIE	4 ans
QUALITÉ / PRIX	Bon
DISTINCTION	Détecteur de lumière du jour

05 ÉCLAIRAGES PUBLICS LED

Streetlight LED



Options disponibles : avec détecteur de lumière du jour · 30W, 50W, 70W, 100W ou 150W · 4000K · Garantie 4 ans · Asymétrique 70x140° · IP65 · IK06 · Class I · Température d'utilisation -20~40°C · CE / RoHS



		#	W	LM	LM/W	K					
		Standard	☀️								
1	30W 3600LM 4000K	249066	30	3600	120	4000	×	Type III	25,000	416x138x105	
2	50W 6000LM 4000K	249067 249071	50	6000	120	4000		Type III	25,000	470x149x105	
3	70W 8400LM 4000K	249068 249072	70	8400	120	4000		Type III	25,000	470x149x105	
4	100W 12000LM 4000K	249069 249073	100	12000	120	4000		Type III	25,000	567x179x105	
5	150W 18000LM 4000K	249070 249074	150	18000	120	4000		Type III	25,000	633x203x105	

Plus de détails

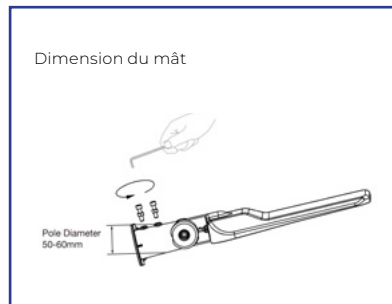





HUBLOTS LED



BEST



Hublot Pro V2

PUISSANCE	12/16/20W
LUMEN	Max 2400
LM/W	120
IP / IK	IP65 / IK10
OPTIONS	Détecteur & urgence
SWITCH	CCT & Puissance
DURÉE DE VIE L70	100,000h
GARANTIE	6 ans
QUALITÉ / PRIX	Excellent
DISTINCTION	Détecteur & urgence Collerette & visière noir

p.48



Corido V2

PUISSANCE	12/16/20W
LUMEN	Max 2000
LM/W	100
IP / IK	IP44 / IK02
OPTIONS	Détecteur & urgence
SWITCH	CCT & Puissance
DURÉE DE VIE L70	100,000h
GARANTIE	4 ans
QUALITÉ / PRIX	Bon
DISTINCTION	Détecteur & urgence







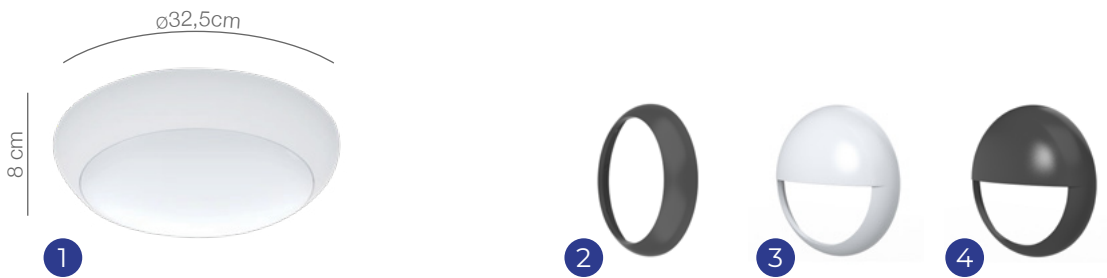

p.49

07 HUBLOTS LED

Hublot LED Pro V2



Fixation parfaite contre le vandalisme · Idéal pour les couloirs, les cages d'escalier et les parkings · Options disponibles : Version détecteur / urgence ou les deux · Différentes finitions disponibles en noir ou blanc · Switch de puissance · Switch 3CCT (3000K, 4000K, 6500K) · Garantie 6 ans · 120° · IP65 · IK10 · Class II · PF>0,9 · Polycarbonate · Température d'utilisation -20~40°C · CE / RoHS

						CE	RoHS	-20~40°C	IK10	IP65	CRI80	6	
	#					W	LM	LM/W	K				
Standard  ·  ·  + 													
1	12/16/20W 3CCT Ø32,5cm Blanc	251982	251984	251983	251985	12/16/20	1450/1920/2400	120	3000/4000/6500	×	120°	100,000	Ø325x80
Accessoires													
2	Collerette - Noir	251992											
3	Visière cercle - Blanc	251993											
4	Visière cercle - Noir	251994											
	Détecteur	251990											
	Module d'urgence	251991											

Plus de détails

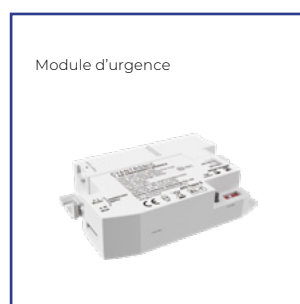

07 HUBLOTS LED

Hublot LED Corido V2

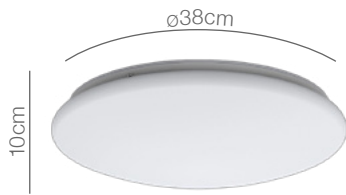

Idéal pour les couloirs, les cages d'escalier et les salles de bains · Options disponibles : Version détecteur / urgence ou les deux · Switch de puissance · Switch 3CCT (3000K, 4000K, 6500K) · Garantie 4 ans · 120° · IP44 · IK02 · Class I · SPCC · Température d'utilisation -20~40°C · CE / RoHS

						CE		 -20~40°C	IK02	IP44	CRI80		
	#					W	LM	LM/W	K				
Standard													
1	12/16/20W 3CCT Ø38cm Blanc	251986	251988	251987	251989	12/16/20	1200/1600/2000	100	3000/4000/6500	×	120°	100,000	Ø380x10
Accessoires													
Détecteur		251990											
Module d'urgence		251991											

Plus de détails

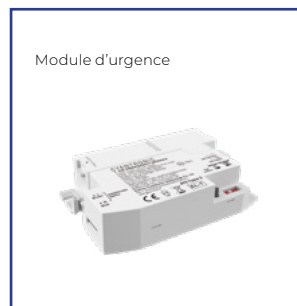



RUBANS LED



Naga

PUISSANCE	4,8W/m - 16W/m
LUMEN	310 - 1440
LM/W	90lm/w
IP	IP65 & IP20
OPTIONS	Dual white & RGB
SWITCH	CCT pour Dual white & RGB
DURÉE DE VIE L70	50,000h
GARANTIE	6 ans
QUALITÉ / PRIX	Excellent
DISTINCTION	COB & SMD Nombreux accessoires disponibles

08 RUBANS LED

Ruban LED Naga



COB & SMD · Ruban de 5M · 2700K, 3000K, 4000K & 6500K · Rubans couleur unique sont fournis avec un câble DC · Dual white & RGB · Garantie 6 ans · 120° & 180° · IP20 & IP65 · Class III · Température d'utilisation -20~45°C · CE / RoHS

		#				W/M			LM/M			LM/W			
IP20		2700K	3000K	4000K	6500K	Dual white	RGB + Dual white								
1	SMD60 4.8W/m 5M	252781	252782	252783	252784			4,8	Max 600	125	✓	120°	50,000	5000mm	
2	SMD120 9.6W/m 5M	252785	252786	252787	252788			9,6	Max 870	91		120°	50,000	5000mm	
3	SMD240 16W/m 5M	252789	252790	252791	252792			16	Max 1440	90		120°	50,000	5000mm	
4	COB320 8W/m 5M	252793	252794	252795	252796			8	Max 950	119		180°	50,000	5000mm	
5	SMD120 9.6W/m CCT 5M					251642		9,6	Max 430	45		120°	50,000	5000mm	
6	SMD90 12W/m RGB+CCT 5M						251640	12	Max 310	25		120°	50,000	5000mm	
IP65															
1	SMD60 4.8W/m 5M	251644	251646	251648	251650			4,8	Max 600	125	✓	120°	50,000	5000mm	
2	SMD120 9.6W/m 5M	251652	251654	251609	251611			9,6	Max 870	91		120°	50,000	5000mm	
3	SMD240 16W/m 5M	251613	251615	251617	251619			16	Max 1440	90		120°	50,000	5000mm	
4	COB320 8W/m 5M	251621	251623	251625	251627			8	Max 950	119		180°	50,000	5000mm	
5	SMD120 9.6W/m CCT 5M					251631		9,6	Max 430	45		120°	50,000	5000mm	
6	SMD90 12W/m RGB+CCT 5M						251629	12	Max 310	25		120°	50,000	5000mm	

Plus de détails

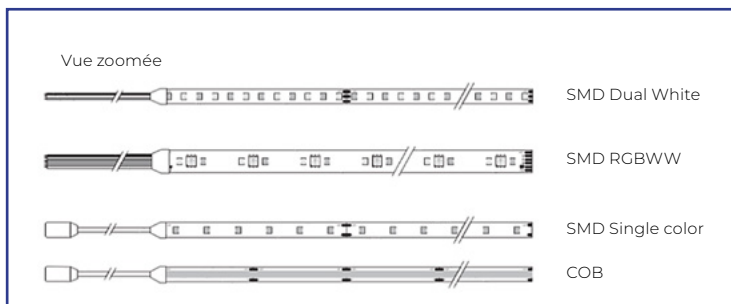

Drivers



	#	
	IP20	IP65
35W + câble raccordement 2M	251941	-
50W + câble raccordement 2M	251942	-
75W + câble raccordement 2M	251943	251948
100W + câble raccordement 2M	251944	251949
150W + câble raccordement 2M	251945	251950
200W + câble raccordement 2M	251946	251951
320W + câble raccordement 2M	-	251952
400W + câble raccordement 2M	251947	-

Accessoires



		#			
		SMD60/120 & COB320 Couleur unique	SMD240 Couleur unique	SMD120 Dual white	SMD90 RGB + Dual white
1	Câble Power DC	251633	251633	-	-
2	Connecteur ruban à ruban	251635	251645	251655	251657
3	Connecteur 15cm de ruban à fil	251637	251647	251656	251658
4	Connecteur 15cm de ruban à ruban	251639	251649	251662	251659
5	Connecteur 15cm de ruban à câble DC	251641	251651	-	-
6	Connecteur ruban à câble	-	-	-	251660
7	Connecteur ruban à ruban 90°	251643	251653	251663	251661



DOWNLIGHTS LED



BEST



Slim V2



Ecowhite



Apollo V2



Hera



Leto



Triton



Forza V2



	Slim V2	Ecowhite	Apollo V2	Hera	Leto	Triton	Forza V2
PUISSANCE	12W - 24W	18W	6W - 25W	9W - 21W	8W - 15W	13,5W - 18,5W	28/32/36/40W
LUMEN	1200 - 2400	1400 - 1530	690 - 3060	800 - 2550	960 - 1800	1700 - 2400	Max 4300
LM/W	100	85	130	121	120	120	Max 117
IP / IK	IP44 / IK02	IP20 / IK05	IP20 / IK02	IP54 / IK02	IP44 / IK02	IP54 / IK03	IP20 / IK02
TAILLE DE COUPE	ø15cm - ø20cm	ø5,5-17,5cm	ø12cm - ø15cm ø20cm	ø12cm - ø15cm ø20cm	ø11,5cm ø14cm - ø18cm	ø15cm - ø17,5cm ø20cm - ø22,5cm	ø16cm
OPTIONS	DALI & Urgence	×	Dali & urgence sur demande	×	×	×	Dali & urgence sur demande
SWITCH	×	CCT	CCT & Puissance	CCT	×	CCT & Puissance	CCT & Puissance
DURÉE DE VIE L70	50,000h	30,000h	100,000h	30,000h	50,000h	50,000h	60,000h
GARANTIE	6 ans	4 ans	6 ans	4 ans	6 ans	6 ans	6 ans
QUALITÉ / PRIX	Très bon	Bon	Excellent	Bon	Très bon	Très bon	Très bon
DISTINCTION	DALI & Urgence	Switch CCT 4 couleurs	Switch CCT & Puissance Alu réflecteur	Switch CCT Noir disponible	Alu réflecteur	Switch CCT & Puissance	IRC90 Dispo. en noir

p.56

p.57

p.58

p.59

p.60

p.61

p.62

09 DOWNLIGHTS LED

Downlight LED Slim V2

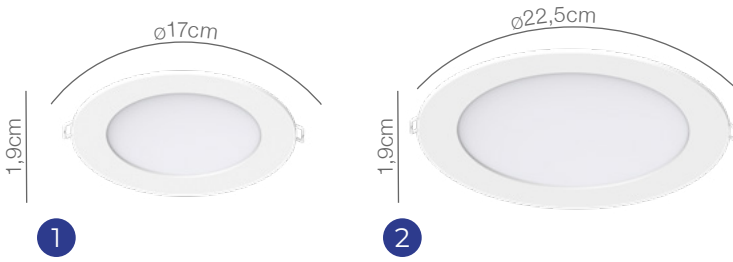

Downlight extra fin (19mm) · Sans scintillement · 3000K ou 4000K · Taille de coupe : 15 ou 20cm · Garantie 6 ans · 120° · IP44 · IK02 · Class II · FP>0,9 · SPCC / Aluminium · Température d'utilisation -20~45°C · CE / RoHS



		Standard			W				LM				LM/W		K		Beam		Life		Cutout	
		#			W				LM				LM/W		K		Beam		Life		Cutout	
1	12W 1200LM 3000K Ø15cm	238898	238904	249233	12	1200	100	3000	120°	50,000	ø170x19											
	12W 1200LM 4000K Ø15cm	238899	238905		12	1200	100	4000														
2	20W 2000LM 3000K Ø20cm	238900	238906	238918	20	2000	100	3000	120°	50,000	ø225x19											
	20W 2000LM 4000K Ø20cm	238901	238907	238919	20	2000	100	4000														
	24W 2400LM 3000K Ø20cm	238902	238908		24	2400	100	3000														
	24W 2400LM 4000K Ø20cm	238903	238909		24	2400	100	4000														

Plus de détails



09 DOWNLIGHTS LED

Downlight LED Ecowhite

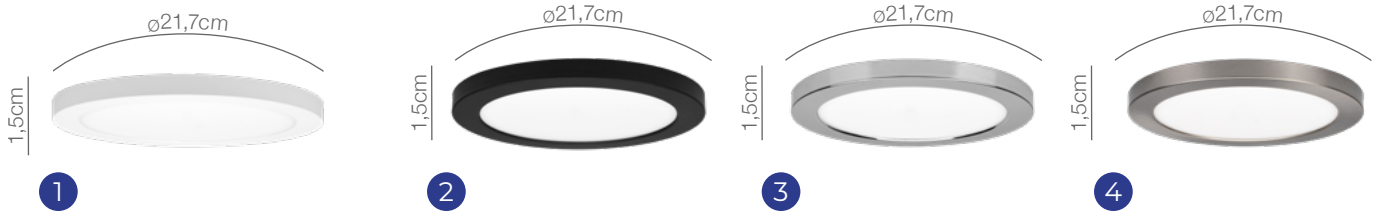

Downlight en surface avec des collerettes colorés (Noir, Chrome, Nickel) pour s'adapter à toutes les installations · Sans scintillement · Switch 3CCT (3000K, 4000K, 6500K) · Diamètre ajustable : 5,5-17,5cm · Garantie 4 ans · Dimmable · 110° · IP20 · IK05 · Class II · FP>0,9 · Plastique / PMMA / PS / PET · Température d'utilisation -20~40°C · CE / RoHS



1	18W 3000/4000/6000K 3CCT Ø5,5-17,5cm	245015	18	1400/ 1530/1400	78/ 85/78	3000/ 4000/6500	✓	110°	30,000	Ø217x15	
Accessoires											
2	Collerette - noir Ø21,7cm	245016									Ø217x15
3	Collerette - chrome Ø21,7cm	245017									Ø217x15
4	Collerette - nickel Ø21,7cm	245018									Ø217x15

Plus de détails









09 DOWNLIGHTS LED

Downlight LED Apollo V2



Idéal pour l'installation dans les couloirs, les espaces communs dans les bureaux, les hôtels, les restaurants · Options disponibles : avec réflecteur (UGR<19) · Dali & urgence disponible sur demande · Sans scintillement · 2CCT switch (3000K, 4000K) · Taille de coupe : 12, 15, 20cm · Garantie 6 ans · 60° · IP20 · IK02 · Class II · FP>0,8 · Aluminium / PC · Température d'utilisation -20~40°C · CE / RoHS



		#	W	LM	LM/W	K							
Standard													
1	6/9/12W 2CCT Ø12cm	248329	6	720/760	124/130	3000/4000		60°	100,000	Ø145x92			
			9	1060/1120	122/128	3000/4000							
			12	1400/1500	120/126	3000/4000							
2	6/9/12W 2CCT Ø12cm Alu	248323	6	690/730	120/126	3000/4000			60°	100,000	Ø145x92		
			9	1030/1090	118/124	3000/4000							
			12	1360/1460	116/122	3000/4000							
1	9/12/15W 2CCT Ø15cm	248324	9	1080/1140	122/128	3000/4000				60°	100,000	Ø175x108	
			12	1420/1520	120/126	3000/4000							
			15	1740/1860	118/124	3000/4000							
2	9/12/15W 2CCT Ø15cm Alu	248325	9	1060/1120	118/124	3000/4000					60°	100,000	Ø175x108
			12	1380/1480	116/122	3000/4000							
			15	1680/1800	114/120	3000/4000							
1	15/20/25W 2CCT Ø20cm	248326	15	1800/1920	122/128	3000/4000					60°	100,000	Ø220x140
			20	2380/2520	120/126	3000/4000							
			25	2900/3060	118/124	3000/4000							
2	15/20/25W 2CCT Ø20cm Alu	248327	15	1740/1860	118/124	3000/4000					60°	100,000	Ø220x140
			20	2280/2420	116/122	3000/4000							
			25	2800/2960	114/120	3000/4000							
Accessoires													
3	Collerette Int Ø12cm - Ext Ø16,7cm	243085									Ø167x10		
	Collerette Int Ø20cm - Ext Ø24cm	243086									Ø240x10		

Plus de détails







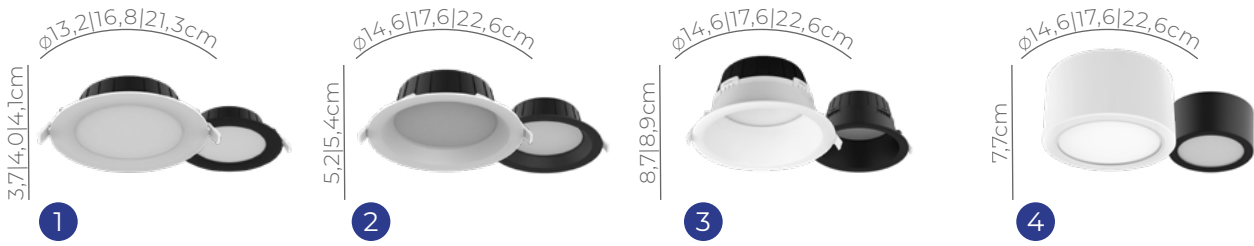





09 DOWNLIGHTS LED

Downlight LED Hera



Disponible en blanc et en noir · Installation à plat, en encastré ou en surface · Switch 3CCT (2700K, 3000K, 4000K) · Taille de coupe : 12, 15, 20cm · Garantie 4 ans · I10° · IP54 · IK02 · Température d'utilisation -20~40°C · CE / RoHS

      											
         											
Flat	○ ●										
1	9W 3CCT Ø12cm	252185	252184	9	800/900/900	89/100/100	2700/3000/4000	×	80°	30,000	Ø132x37
	9W 3CCT Ø15cm	252199	252198	15	1350/1500/1500	90/100/100	2700/3000/4000		80°	30,000	Ø168x40
	21W 3CCT Ø20cm	252187	252186	21	2200/2400/2400	105/114/105	2700/3000/4000		100°	30,000	Ø213x41
Medium encastré											
2	9W 3CCT Ø12cm	252189	252188	9	800/900/900	89/100/100	2700/3000/4000	×	80°	30,000	Ø146x52
	15W 3CCT Ø15cm	252191	252190	15	1350/1500/1500	90/100/100	2700/3000/4000		80°	30,000	Ø176x54
	21W 3CCT Ø20cm	252200	252192	21	2200/2400/2400	105/114/105	2700/3000/4000		100°	30,000	Ø226x54
Deep encastré											
3	9W 3CCT Ø12,5cm	252201	252193	9	800/900/900	89/100/100	2700/3000/4000	×	80°	30,000	Ø146x87
	15W 3CCT Ø15,5cm	252202	252194	15	1350/1500/1500	90/100/100	2700/3000/4000		80°	30,000	Ø176x89
	21W 3CCT Ø21cm	252203	252195	21	2200/2400/2400	105/114/105	2700/3000/4000		100°	30,000	Ø226x89
Surface											
4	15W 3CCT Ø15cm	252204	252196	15	1500/1700/1700	100/114/114	2700/3000/4000	×	100°	30,000	Ø150x77
	21W 3CCT Ø20cm	252205	252197	21	2300/2550/2550	110/121/121	2700/3000/4000		100°	30,000	Ø200x77

Plus de détails



09 DOWNLIGHTS LED

Downlight LED Leto



Idéal pour l'éclairage des commerces · Spot encastré réflecteur · 3000K ou 4000K · Drivers Philips · Taille de coupe : 13,3, 16,5 or 20,5cm · Garantie 6 ans · 70° · IRC90 · IP20 · IK02 · Température d'utilisation -20~40°C · CE / RoHS



W LM LM/W K ×

8W 960LM 930 Ø11,5cm	252802	8	960	120	3000	×	70°	80,000	ø133x70
8W 960LM 940 Ø11,5cm	252803	8	960	120	4000		70°	80,000	ø133x70
12W 1440LM 930 Ø14cm	252804	12	1440	120	3000		70°	80,000	ø165x86
12W 1440LM 940 Ø14cm	252805	12	1440	120	4000		70°	80,000	ø165x86
15W 1800LM 930 Ø18cm	252806	15	1800	120	3000		70°	80,000	ø205x98
15W 1800LM 940 Ø18cm	252807	15	1800	120	4000		70°	80,000	ø205x98

09 DOWNLIGHTS LED

Downlight LED Triton

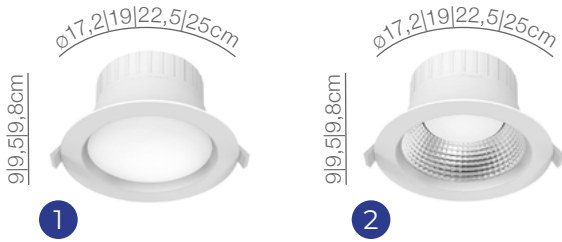

Options disponibles : avec réflecteur (100°) · Switch de puissance : 13,5/18,5W · Switch 2CCT (3000K, 4000K) · Taille de coupe : 15, 17,5, 20, 22,5cm · Garantie 6 ans · 90° · IP54 · IK03 · Température d'utilisation -20~40°C · CE / RoHS

      										
         										
Diffuseur										
1	13,5/18,5 2CCT Ø15cm	250425	13,5/18,5	1800/2400	120	3000/4000	×	90°	90,000	Ø172x90
	13,5/18,5 2CCT Ø17,5cm	250763	13,5/18,5	1800/2400	120	3000/4000		90°	90,000	Ø190x95
	13,5/18,5 2CCT Ø20cm	250429	13,5/18,5	1800/2400	120	3000/4000		90°	90,000	Ø225x98
	13,5/18,5 2CCT Ø22,5cm	250765	13,5/18,5	1800/2400	120	3000/4000		90°	90,000	Ø250x98
Réflecteur										
2	13,5/18,5 2CCT Ø15cm	250424	13,5/18,5	1700/2300	120	3000/4000	×	100°	90,000	Ø172x90
	13,5/18,5 2CCT Ø17,5cm	250426	13,5/18,5	1700/2300	120	3000/4000		100°	90,000	Ø190x95
	13,5/18,5 2CCT Ø20cm	250764	13,5/18,5	1700/2300	120	3000/4000		100°	90,000	Ø225x98
	13,5/18,5 2CCT Ø22,5cm	250430	13,5/18,5	1700/2300	120	3000/4000		100°	90,000	Ø250x98

Plus de détails

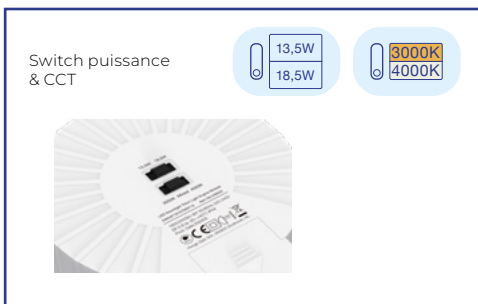

09 DOWNLIGHTS LED

Downlight LED Forza V2

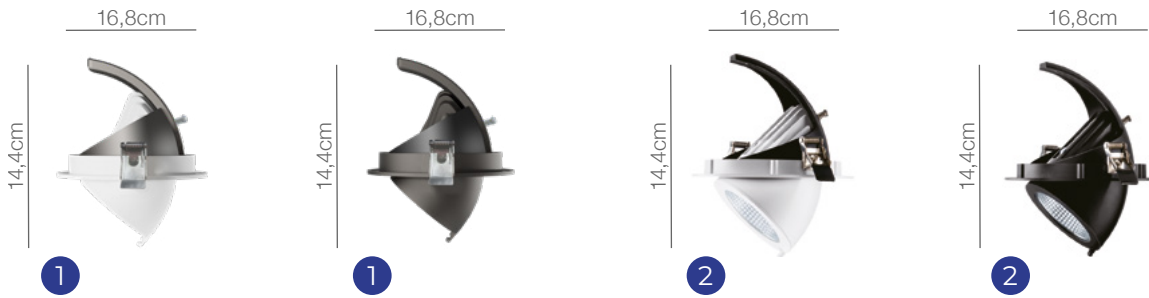

Idéal pour l'éclairage des magasins · 45° inclinable & 355° rotation · Disponible en blanc et noir · Switch de puissance · Switch CCT · Dali & urgence disponible sur demande · Taille de coupe : 16,8cm · Garantie 6 ans · UGR<19 · 36° · IP20 · IK02 · Class II · FP>0,9 · Aluminium · Température d'utilisation -20~45°C · CE / RoHS

<div style="display: flex; justify-content: space-between; align-items: center;"> <div style="display: flex; gap: 10px;"> CE RoHS Temp: -20~45°C IK02 IP20 CRI90 6 </div> <div style="display: flex; gap: 10px;"> # W LM LM/W K Rotation Inclinaison Temps mm </div> </div>											
Forza V2 ○ ●											
1	28/32/36/40W 3CCT 36° Ø16,8cm	255939	255940	28	3000/3300/3200	107/117/114	3000/4000/5700	×	36°	60,000	168X144
				32	3300/3700/3700	103/115/115	3000/4000/5700				
				36	3700/4100/4000	102/113/111	3000/4000/5700				
				40	3900/4500/4300	98/113/108	3000/4000/5700				
Forza V1											
2	35W 3100LM 930 36° Ø16,8cm	245302	245304	35	3100	90	3000	×	36°	50,000	168X144
	35W 3200LM 940 36° Ø16,8cm	245303		35	3200	92	4000		36°	50,000	168X144

Plus de détails







ÉCLAIRAGES DE SECOURS

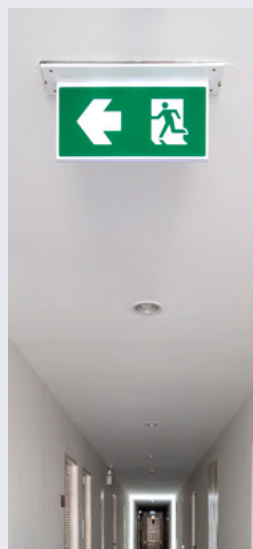

BEST



Éclairage de secours autotest



Hublot d'urgence



Éclairage de secours exit

PUISSANCE	3,5W	8,5W	3,5W
IP / IK	IP20 / IK06	IP20 / IK06	IP40 / IK04
OPTIONS	Urgence & Détecteur	Urgence	Urgence
SWITCH	×	×	×
DURÉE DE VIE L70	50,000h	30,000h	30,000h
GARANTIE	3 ans	2 ans	3 ans
QUALITÉ / PRIX	Excellent	Très bon	Très bon

10 ÉCLAIRAGES DE SECOURS

Éclairage de secours Autotest

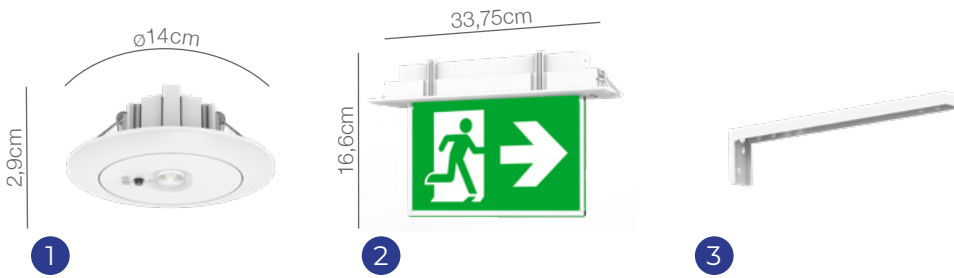

1	Spot Blanc 3W 240lm - 850K Blanc Froid Urgence 3H - Autotest - Ø14cm	245469	3	5000	3H	24H	1500mAh LiFePO4 6.4V	50,000	Ø140x29,5
2	Affichage de secours 1W 20lm 6000K Urgence 3H - Autotest - incl. 4 directions	245470	3.5	6000	3H	24H	1500mAh LiFePO4 3.2V	50,000	337.5x166x43
3	Kit pour installation sur le côté	245471							

Plus de détails

4 directions en PVC

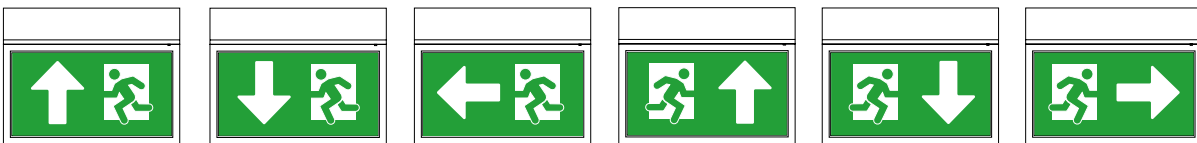

10 ÉCLAIRAGES DE SECOURS

Hublot d'urgence



1	Applique d'urgence LED* 8.5W 500lm 6500K Urgence 3H - incl. 4 directions	245467	8.5	6500	3H	24H	Ni-Cd SC3.6V 2Ah	30,000	352x110x68
2	Cadre semi encastré	245468							

Plus de détails

4 directions en PVC



10 ÉCLAIRAGES DE SECOURS

Éclairage de secours Exit



1	Éclairage urgence plafond 3.5W 6000K Urgence 3H - incl. 4 directions	239389	3,5	6000	3H	24H	Ni-Mh 3.6V 0.7Ah	30,000	335x45x245
2	Cadre encastré	239390							
3	Kit de suspension 2M	239391							

Plus de détails

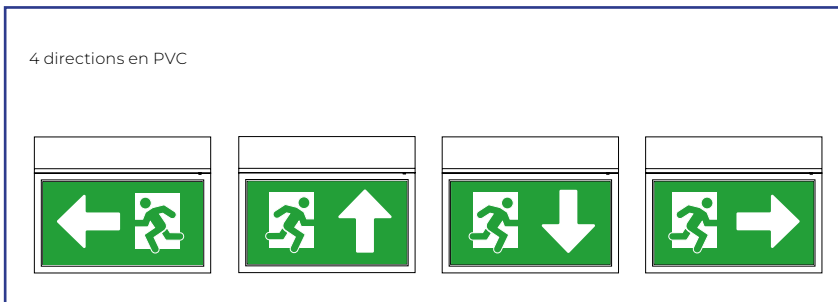





SPOTS SUR RAILS LED



BEST



Delta Pro



Ecowhite



Spot sur rail | GU10

PUISSANCE	20/30/40W	10 - 30W	-
LUMEN	Max 4900	840 - 3210	-
LM/W	Max 125	107	-
IP / IK	IP20 / IK07	IP20 / IK07	IP20 / IK07
DRIVERS	Driver externe KGP	Driver interne KGP	-
OPTIONS	Adaptateur universel	Adaptateur universel	-
SWITCH	CCT & Puissance	×	-
DURÉE DE VIE L70	60,000h	50,000h	-
GARANTIE	6 ans	4 ans	4 ans
QUALITÉ / PRIX	Excellent	Bon	Bon
DISTINCTION	Switch CCT & puissance Driver externe	Driver interne	Pour GU10

Spots sur rails LED Delta Pro



Remplacement luminaires CDM · Adaptateur universel pour s'adapter à la plupart des systèmes de rails standard · Driver KGP externe · Phase 0, 1, 2 et 3 · 90° inclinable & rotation 350° · Disponible en blanc et noir · Switch de puissance 20/30/40W · Switch 3CCT (3000K, 4000K, 5700K) · IRC90 · Garantie 6 ans · UGR<19 · 36° · IP20 · IK07 · Class II · FP>0,9 · Température d'utilisation -20~45°C · CE / RoHS



#	W	LM	LM/W	K	Beam	Life	Temp	Dim	Beam
1	20/30/40W 3CCT 36°	252898	252899						
	20	2300/2500/2500	115/125/125	3000/4000/5700	×	36°	60,000		ø100x190
	30	3400/3700/3600	113/123/120	3000/4000/5700					
	40	4400/4900/4700	110/123/118	3000/4000/5700					
Accessoires									
2	Réflecteur 24°	252916							
2	Réflecteur 60°	252917							
3	Grille nid d'abeille	252918							

Plus de détails

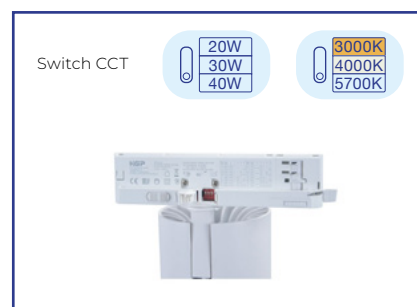

Spots sur rails LED Ecowhite



Remplacement luminaires CDM · Adaptateur universel pour s'adapter à la plupart des systèmes de rails standard · Driver KGP interne · Phase 0, 1, 2 et 3 · 90° inclinable & rotation 350° · Disponible en blanc et noir · 10W, 20W & 30W · 3000K ou 4000K · IRC90 · Garantie 4 ans · UGR<19 · 36° · IP20 · IK07 · Class II · FP>0,9 · Température d'utilisation -20~45°C · CE / RoHS



		#	W	LM	LM/W	K					
		○ ●									
1	10W 840LM 930 36°	252901 252900	10	840	84	3000	×	36°	50,000	ø55x205	
	10W 920LM 940 36°	252903 252902	10	920	92	4000		36°	50,000	ø55x205	
2	20W 1970LM 930 36°	252905 252904	20	1970	99	3000		36°	50,000	ø74x238	
	20W 2060LM 940 36°	252907 252906	20	2060	103	4000		36°	50,000	ø74x238	
3	30W 2960LM 930 36°	252909 252908	30	2960	99	3000		36°	50,000	ø90x253	
	30W 3210LM 940 36°	252911 252910	30	3210	107	4000		36°	50,000	ø90x253	

Plus de détails



Spots sur rails | GU10



Convient pour ampoules LED GU10 · Remplacement luminaires CDM · Adaptateur universel pour s'adapter à la plupart des systèmes de rails standard · 90° inclinable & rotation 350° · Disponible en blanc et noir · Garantie 4 ans · 36° · IP20 · IK07 · Température d'utilisation -20~45°C · CE / RoHS



GU10 disponibles page 84



Suspension | GU10



1 3-Phase Suspension pour GU10 252913 252912



ø55x1150

Spot | GU10

2 3-Phase Spot pour GU10 252915 252914



ø55x193





SPOTS LED

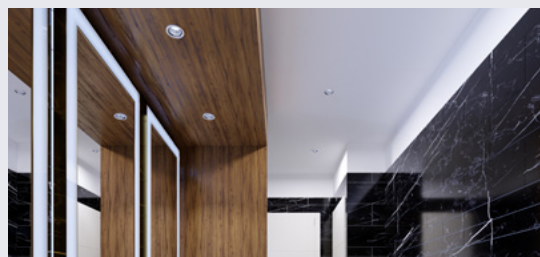

BEST



**Spot slim LED
intégrée**

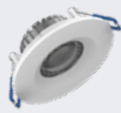

Ares



Spot LED intégrée



**Spot encastré
pour ampoules GU10**

PUISSANCE	6W	6W	8W	-
LUMEN	520 - 550	480 - 540	585 - 700	-
LM/W	93	90	80	-
IP / IK	IP54 / IK02	IP65 / IK02	IP44-65 / IK02	IP20 / IK02
DIMMABLE	✓	✓	✓	-
OPTIONS	-	Résistant au feu	Résistant au feu	-
SWITCH	CCT	CCT	✗	✗
DURÉE DE VIE L70	50,000h	50,000h	50,000h	-
GARANTIE	6 ans	6 ans	6 ans	4 ans
QUALITÉ / PRIX	Très bon	Excellent	Très bon	Très bon
DISTINCTION	Switch 2 CCT Design extra-fin	Switch 3 CCT Fireproof Personnalisable	Différents designs Différentes couleurs	Différents designs Différentes couleurs

12 SPOTS LED

Spot LED Slim Ajustable



Spots ultra fins · Disponible en blanc, noir et aluminium · 6W · 2700K, 3000K, 4000K ou 2CCT (2000K / 3000K) · IRC90 · Taille de coupe : 8,5cm · Garantie 6 ans · Dimmable · 60° · IP54 · IK02 · Aluminium / Polycarbonate · Température d'utilisation -20~40°C · CE / RoHS



	#			W	LM	LM/W	K	Beam	Life	Cutout	
	○	●	●								
6W 520LM 927	245688	245689	245690	6	520	90	2700	✓	60°	50,000	Ø85x28
6W 550LM 930	244924	244925		6	550	93	3000		60°	50,000	Ø85x28
6W 550LM 940	245682	245683		6	550	93	4000		60°	50,000	Ø85x28
6W 2CCT 920-930	245685			6	350	60	2000/ 3000		60°	50,000	Ø85x28

Plus de détails



12 SPOTS LED

Spot LED Ares

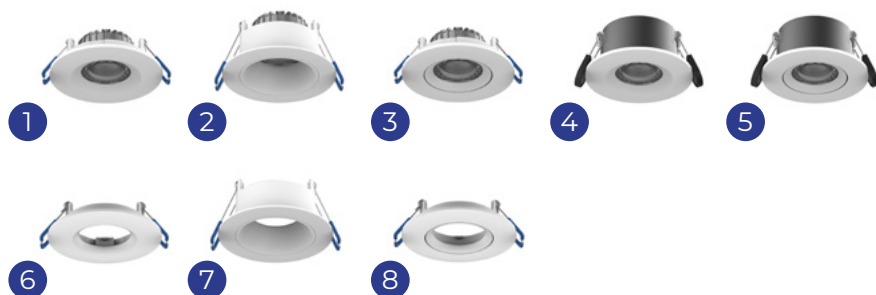

Nombreux design et aspects différents pour s'adapter à toutes les installations · Configuration possible avec différentes couleurs colerettes · 6W · Switch 3CCT (2700, 3000, 4000K) · Taille de coupe : 6,8cm · Garantie 6 ans · Dimmable · 38° · IP65 · IK02 · Class II · FP>0,9 · Aluminium · Température d'utilisation -20~45°C · CE / RoHS



	#	W	LM	LM/W	K						
Avec Led intégrée											
	○ ●										
Ares Fixe 6W 3CCT	253995 253992	6	480/520/540	80/86/90	2700/3000/4000	38°	×	✓	50,000	Ø68x40	
Ares Deep 6W 3CCT	254001 254005	6	480/520/540	80/86/90	2700/3000/4000	38°	×	✓	50,000	Ø68x47	
Ares Orientable 6W 3CCT	253998 253997	6	480/520/540	80/86/90	2700/3000/4000	38°	25°	✓	50,000	Ø68x40	
Ares Fixe Firerated 6W 3CCT	254018 254021	6	480/520/540	80/86/90	2700/3000/4000	38°	×	✓	50,000	Ø68x40	
Ares Orientable Firerated 6W 3CCT	254015 254017	6	480/520/540	80/86/90	2700/3000/4000	38°	25°	✓	50,000	Ø68x40	
Sans Led intégrée GU10											
Ares Fixe	253996 253994						×		Ø80mm	Ø68x40	
Ares Deep	254007 254012						×		Ø73mm	Ø68x47	
Ares Orientable	254000						25°		Ø70mm	Ø68x40	

12 SPOTS LED

Spot LED Intégrée



Nombreux design et aspects différents pour s'adapter à toutes les installations · Disponible en blanc et aluminium · 8W · 2700K · Taille de coupe : 70, 72, 73, 74, 80, 83 ou 92mm · Garantie 6 ans · UGR<15 · Dimmable · 33°/37° · IP44/IP54/IP65 · IK02 · Class II · FP>0,9 · Aluminium / Polycarbonate · Température d'utilisation -20~45°C · CE / RoHS

				CE	RoHS	-20~45°C	IK02	IP44~IP65	CRI90	6		
☹	#	○	●	W	LM	LM/W	K	🏠	📄	🔄	🚫	📏 (mm)
1	Starlight IP54	224361		8	610	70	2700	37°	✗	✓	Ø80mm	85x90
2	Ember IP65 Fireproof	244600	244611	8	585	70	2700	34°	✗	✓	Ø73mm	80x57
3	H2O IP65 Fireproof	244603		8	585	70	2700	34°	✗	✓	Ø70mm	85x70
4	Hydro IP65 Fireproof	244612		8	585	70	2700	34°	30°	✓	Ø83mm	95x63
5	Gimax IP44	224358		8	610	72	2700	33°	✗	✓	Ø74mm	80x57
6	Aqua IP65 Fireproof	242001		8	585	70	2700	33°	30°	✓	Ø92mm	100x64
7	Forseti IP44	224357		8	600	72	2700	37°	✗	✓	Ø72mm	80x75

12 SPOTS LED

Spot Encastré GU10



Spots pour ampoules GU10 · Nombreux design, formes et couleurs différentes · La douille GU10 est incluse, avec un câble de 18cm · Puissance max acceptée 50W · Produit de haute qualité avec des clips solides pour une fixation parfaite au plafond · Disponible en blanc, Noir et aluminium · Garantie 4 ans · IP20 · Aluminium

Spots GU10 disponibles à la page 84



		#					
		○	●	●			
1	Boxi	220658	220657	232027	40°	Ø80mm	92x25
2	Drome	220652	220651	232025	40°	Ø69mm	82x23
3	Logic	220655	220654	232026	40°	Ø80mm	92x25
4	Vision	220649	220648	232024	40°	Ø69mm	82x23
5	D-Flex	220646			40°	Ø70mm	82x24
6	Flox	220640		232022	40°	Ø70mm	82x24
7	D-Round	220644		232023	×	Ø70mm	82x35
8	D-Deep	220645			×	Ø70mm	82x35
9	Fix	220638			×	Ø70mm	82x24
10	Rondo	220647			×	Ø70mm	90x78



AMPOULES LED SPOTS

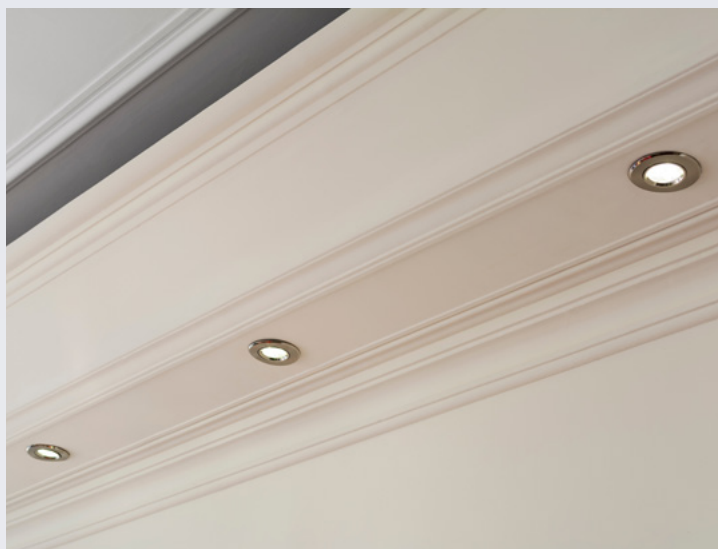

**GU10
PerfectColor**



**GU10
Standard**



**GU4
PerfectColor**



**GU5.3
PerfectColor**



**GU5.3
Standard**



**G53
AR111**



**GU10
Pro AR111**

	GU10 PerfectColor	GU10 Standard	GU4 PerfectColor	GU5.3 PerfectColor	GU5.3 Standard	G53 AR111	GU10 Pro AR111
PUISSANCE	2,6W - 4W	2,4W - 5,5W	1,8W - 4,5W	3W - 7,5W	2,5W - 7,8W	7,2W - 11,7W	12W
LUMEN	260 - 380	230 - 560	184 - 345	230 - 621	230 - 730	450 - 880	600 - 850
LM/W	91	113	84	83	111	78	56
IRC	97	80	90	90	80	97	90
DIMMABLE	✓	✓	✓	✓	✓	✓	✓
DURÉE DE VIE L70	15,000 - 25,000h	25,000h	25,000h	25,000h	15,000 - 25,000h	40,000h	45,000h
GARANTIE	5 ans	3 ans	5 ans	5 ans	3 ans	5 ans	5 ans

13

AMPOULES LED SPOTS

GU10 LED PerfectColor



1



2



3

-20~40°C

CRI80

CRI97

5

	#	W	= W	LM	LM/W	K						
36°												
1	2.6W 230LM 922-927	242054	2,6	35	260	86	2200/2700	F	✓	36°	15,000	Ø50x52
	3W 230LM 927	241672	3	35	260	77	2700					Ø50x52
	3.8W 345LM 922-927	241959	3,8	50	380	91	2200/2700					Ø50x54
	4W 345LM 927	241955	4	50	380	86	2700					Ø50x54
	4W 345LM 930	242050	4	50	380	86	3000					Ø50x54
	4W 345LM 940	243440	4	50	380	86	4000					Ø50x54
	6.7W 575LM 927	250683	6,7	80	575	86	2700					Ø50x53
	6.7W 575LM 930	250684	6,7	80	575	86	3000					Ø50x53
	6.7W 575LM 940	250685	6,7	80	575	86	4000					Ø50x53
60°												
2	3W 230LM 927	242051	3	35	260	77	2700	F	✓	60°	15,000	Ø50x52
	4W 345LM 927	241645	4	50	380	86	2700					Ø50x54
	4W 345LM 930	241646	4	50	380	86	3000					Ø50x54
	4W 345LM 940	241647	4	50	380	86	4000					Ø50x54
	6.7W 575LM 927	250686	6,7	80	575	86	2700					Ø50x53
	6.7W 575LM 930	250687	6,7	80	575	86	3000					Ø50x53
120°												
3	6.7W 650LM 827	250689	6,7	51	650	97	2700	F	✓	120°	25,000	Ø50x55
	6.7W 650LM 830	250690	6,7	51	650	97	3000					
	6.7W 650LM 840	250691	6,7	51	650	97	4000					

13 AMPOULES LED SPOTS

GU10 LED Standard



-20~40°C
 CRI80
 3

	#	W	= W	LM	LM/W	K						
36°												
1	2.4W 230LM 827	242299 254656	2,4	35	230	96	2700	E	X	36°	25,000	Ø50x54
	2.4W 230LM 830	242300 254657	2,4	35	230	96	3000	E				Ø50x54
2	3W 230LM 827	241957	3	35	230	77	2700	F	✓			Ø50x54
	3W 230LM 830	243403	3	35	230	77	3000	F				Ø50x54
1	3.6W 345LM 830	254658	3,6	50	345	96	3000	E	X			Ø50x54
	3.6W 345LM 840	242302 254659	3,6	50	345	96	4000	E				Ø50x54
2	4W 345LM 827	242052	4	50	345	86	2700	F	✓			Ø50x54
	4W 345LM 830	241648	4	50	345	86	3000	F				Ø50x54
	4W 345LM 840	244564	4	50	345	86	4000	F				Ø50x54
	4.8W 450LM 827	242053	4,8	65	450	94	2700	E	X			Ø50x54
	4.8W 450LM 840	242298	4,8	65	450	94	4000	F				Ø50x54
	5.5W 560LM 827	250692	5,5	78	560	102	2700	E				Ø50x53
	5.5W 560LM 830	241958	5,5	78	560	102	3000	E	Ø50x54			
60°												
2	5.5W 560LM 830	250694	5,5	78	560	102	3000	E	X	60°	25,000	Ø50x53
	5.5W 560LM 840	250695	5,5	78	560	102	4000	E				
120°												
3	5.5W 620LM 830	250697	5,5	50	620	112	3000	E	X	120°	25,000	Ø50x55
	5.5W 620LM 840	250698	5,5	50	620	112	4000	E				

13

AMPOULES LED SPOTS

GU4 LED PerfectColor



Navigation icons: #, W, = W, LM, LM/W, K, and various functional icons (light, refresh, home, clock, dimensions).

PerfectColor 36°												
#	W	= W	LM	LM/W	K							
2.8W 184LM 927 250437 254684	2,8	20	184	72	2700	G	×	36°	25,000	Ø35x38		
2.8W 184LM 927 254714	2,8	20	184	72	2700		✓					
4.5W 345LM 927 250438 254685	4,5	35	345	84	2700		×					
4.5W 345LM 927 250436 254713	4,5	35	345	84	2700		✓					
Standard 36° (3 ans de garantie)												
1.8W 184LM 827 250680	1,8	20	184	102	2700	E	×	36°	25,000	Ø35x46		

13

AMPOULES LED SPOTS

GU5.3 LED PerfectColor



🌡️ -20~40°C

CRI90

5

🔍	#	W	= W	LM	LM/W	K	📄	🔄	🏠	🕒	📏 (mm)
36°											
3W 230LM 927	251855	3	20	230	77	2700	F	✓	36°	25,000	Ø50x46,5
3W 230LM 930	251856	3	20	230	77	3000	F				
4.5W 345LM 927	251859	4,5	35	345	77	2700	F				
4.5W 345LM 930	251860	4,5	35	345	77	3000	F				
4.5W 345LM 940	251861	4,5	35	345	77	4000	F				
7.5W 621LM 927	251867	7,5	50	621	83	2700	F				
7.5W 621LM 930	251868	7,5	50	621	83	3000	F				
60°											
4.5W 345LM 927	251862	4,5	35	345	77	2700	F	✓	60°	25,000	Ø50x46,5
4.5W 345LM 930	251863	4,5	35	345	77	3000	F				
7.5W 621LM 927	251870	7,5	50	621	83	2700	F				
7.5W 621LM 930	251871	7,5	50	621	83	3000	F				
7.5W 621LM 940	251872	7,5	50	621	83	4000	F				

13

AMPOULES LED SPOTS

GU5.3 LED MR16



-20~40°C

CRI80

3

#

W

= W

LM

LM/W

K



36°

#	W	= W	LM	LM/W	K							
2.5W 230LM 827	242055	2,5	20	230	92	2700	F	×	36°	15,000	Ø50x46,5	
2.9W 230LM 827	251853	2,9	20	230	79	2700	F	×		25,000	Ø50x46,5	
3.4W 345LM 840	244207	3,4	35	345	101	4000	E	×		15,000	Ø50x44	
4W 345LM 827	242056	4	35	345	86	2700	F	×		15,000	Ø50x46,5	
4.4W 345LM 827	251857	4,4	35	345	78	2700	F	×		25,000	Ø50x46,5	
4.4W 345LM 830	251873	4,4	35	345	78	3000	F	×		25,000	Ø50x46,5	
4.4W 345LM 840	242303	4,4	35	345	78	4000	F	✓		25,000	Ø50x46,5	
6.1W 621LM 830	251864	6,1	50	621	102	3000	E	×		25,000	Ø50x48	
6.1W 621LM 830	244206 251865	6,1	50	621	102	3000	E	×		15,000	Ø50x44	
6.1W 621LM 840	244205 251866	6,1	50	621	102	4000	E	×		15,000	Ø50x44	
7.5W 621LM 827	244369 254667	7,5	50	621	83	2700	F	✓		25,000	Ø50x44	
7.5W 621LM 830	242306 254663	7,5	50	621	83	3000	F	✓		25,000	Ø50x44	

60°

4.4W 345LM 827	242304	4,4	35	345	78	2700	F	✓	60°	25,000	Ø50x44
4.4W 345LM 830	242305 254662	4,4	35	345	78	3000	F				
7.5W 621LM 827	244368 254666	7,5	50	621	83	2700	F				
7.5W 621LM 830	242307 254664	7,5	50	621	83	3000	F				
7.5W 621LM 840	242308 254665	7,5	50	621	83	4000	F				

13

AMPOULES LED SPOTS

G53 / GU10 LED AR111



-20~40°C
 CRI97
 5

		#	W	= W	LM	LM/W	K					
G53 24°												
1	7.2W 450LM 918-927	244361 249460	7,2	50	450	63	1800/ 2700	G	✓	24°	40,000	Ø110.7x55
	7.4W 450LM 930	242290 254676	7,4	50	450	61	3000	G				
	11.7W 800LM 927	249465 254679	11,7	75	800	75	2700	G				
	11.7W 800LM 930	249466 254680	11,7	75	800	75	3000	G				
G53 40°												
2	7.2W 450LM 918-927	244362 254675	7,2	50	450	68	1800/ 2700	G	✓	40°	40,000	Ø110.7x55
	7.4W 450LM 927	242291 254677	7,4	50	450	61	2700	G				
	7.4W 450LM 930	242292 254678	7,4	50	450	61	3000	G				
	11.7W 800LM 927	249467 254681	11,7	75	800	75	2700	G				
	11.7W 800LM 930	248924 254670	11,7	75	800	75	3000	G				
GU10 40°												
3	12W 600LM 927	242314	12	50	600	50	2700	E	✓	40°	45,000	Ø111x93
	12W 600LM 930	242315	12	50	600	50	3000	E				Ø111x93
	15W 850LM 927	242316	15	75	850	56	2700	E				Ø111x104
	15W 850LM 930	242317	15	75	850	56	3000	E				Ø111x104



AMPOULES LED



Classic

Filament
Classic

TSlim & Stick



Lustre

Filament
Lustre

Candle

PUISSANCE	5,5W - 14W	4,5W - 12W	7W - 9,5W	2,5W - 5,5W	1,4W - 4,5W	2,5W - 4,5W
LUMEN	470 - 1521	470 - 1521	806 - 1050	136 - 470	136 - 470	250 - 470
LM/W	121	145	115	104	104	104
IRC	80 - 90	80	80	80	80	80
CULOT	E27	E27	E27	E14 - E27	E14 - E27	E14
FORME	A60 - A65	A60 - ST64 - G95 - G125	T32 - T37	P45	P45	B35 - BA35
DIMMABLE	✓	✓	✓	✓	✓	✓
DURÉE DE VIE L70	15,000h	15,000h	15,000h	15,000h - 25,000h	15,000h	15,000h
GARANTIE	3 ans	3 ans	3 ans	3 ans	3 ans	3 ans

14

AMPOULES LED

Ampoule LED Lucent Classic



-20~40°C

CRI80

CRI90

3

	#	W	= W	LM	LM/W	K							
PRO A60 E27													
1	5.5W 470LM 827	244551	5,5	40	470	94	2700	F	✓	180°	15,000	Ø60x112	
	9W 806LM 922-927	241909	9	60	806	90	2200/2700	F		180°	15,000	Ø60x115	
2	12.5W 1521LM 827	249456 254672	12,5	100	1521	121	2700	E	✗	220°	15,000	Ø60x115	
	12.5W 1521LM 840	254673	12,5	100	1521	121	4000	E		220°	25,000	Ø60x115	
A60 E27													
3	4.9W 470LM 827	241938	4,9	40	470	98	2700	F	✗	180°	15,000	Ø60x108	
	4.9W 470LM 830	241939	4,9	40	470	98	3000	F		180°	15,000	Ø60x108	
	4.9W 470LM 840	242030	4,9	40	470	98	4000	F		180°	15,000	Ø60x108	
	8W 806LM 827	242283	8	60	806	101	2700	F		180°	15,000	Ø60x108	
	8W 806LM 840	241940	8	60	806	101	4000	F		180°	15,000	Ø60x108	
4	8.5W 806LM 827	242285	8,5	60	806	95	2700	F	✓	150°	15,000	Ø60x112	
	8.5W 806LM 830	242031	8,5	60	806	95	3000	F		✗	180°	15,000	Ø60x108
	9.5W 1055LM 827	241941	9,5	75	1055	111	2700	E	180°		15,000	Ø60x109	
	9.5W 1055LM 830	241942	9,5	75	1055	111	3000	E	180°		15,000	Ø60x109	
	9.5W 1055LM 840	241943	9,5	75	1055	111	4000	E	180°	15,000	Ø60x109		
5	11W 1055LM 827	241944	11	75	1055	96	2700	F	✓	180°	15,000	Ø60x120	
	13W 1521LM 830	242284	13	100	1521	117	3000	E	✗	180°	15,000	Ø60x120	
A65 E27													
5	14W 1521LM 827	241945	14	100	1521	109	2700	F	✓	150°	15,000	Ø60x120	

14 AMPOULES LED

Ampoule LED Lucent Filament



🌡️ -20~40°C

CRI80

3

	#	W	= W	LM	LM/W	K						
A60 E27 FILAMENT												
1	4.5W 470LM 822-827	242057	4,5	40	470	104	2200/2700	F	✗	360°	15,000	Ø60x104
	4.5W 470LM 827	241948	4,5	40	470	104	2700	F		360°	15,000	Ø60x104
	4.5W 470LM 840	244561	4,5	40	470	104	4000	E	✓	360°	15,000	Ø60x104
	7W 806LM 822-827	242058	7	60	806	115	2200/2700	E		360°	15,000	Ø60x104
	7W 806LM 827	241949	7	60	806	115	2700	E		360°	15,000	Ø60x104
	7W 806LM 827	241591	7	60	806	115	2700	E	✗	360°	15,000	Ø60x104
	7W 806LM 840	244560	7	60	806	115	4000	E	✗	360°	15,000	Ø60x104
2	7W 630LM 822 Ambrée	254639	7	60	630	90	2200	F	✓	320°	15,000	Ø60x108
	7.2W 630LM 822 Ambrée	240926	7,2	50	630	88	2200	F		320°	15,000	Ø60x108
1	8.5W 1055LM 827	242286	8,5	75	1055	124	2700	E	✗	360°	15,000	Ø60x104
	9W 1055LM 827	244559	9	75	1055	117	2700	E	✓	360°	15,000	Ø60x104
	10.5W 1521LM 827	248346	10,5	100	1521	145	2700	D	✗	330°	15,000	Ø60x108
	11W 1521LM 827	254671	11	100	1521	138	2700	D	✓	320°	15,000	Ø60x108
	11.2W 1521LM 827	249455	11,2	100	1521	135	2700	D		300°	15,000	Ø60x104
ST64 E27 FILAMENT												
3	4W 470LM 827	242281	4	40	470	118	2700	E	✗	300°	15,000	Ø64x141
4	7W 630LM 822 Ambrée	254641	7	50	630	90	2200	F	✓	320°	15,000	Ø64x141
	7.2W 630LM 822 Ambrée	240929	7,2	50	630	88	2200	F		320°	15,000	Ø64x141
G95 E27 FILAMENT												
5	7W 806LM 827	249458	7	60	806	115	2700	E	✓	360°	15,000	Ø95x140
	7W 806LM 827	254645	7	60	806	115	2700	E	✗	330°	15,000	Ø95x140
G125 E27 FILAMENT												
6	7W 630LM 822 Ambrée	254642	7	50	630	90	2200	F	✓	320°	15,000	Ø125x178
	7.2W 630LM 822 Ambrée	240930	7,2	50	630	88	2200	F		320°	15,000	Ø125x175

14 AMPOULES LED

Ampoule LED Lucent Classic TSlim & Stick



-20~40°C CRI80 3

	#	W	= W	LM	LM/W	K							
T32													
1	7W 806LM 827 250754 254686	7	60	806	115	2700	E	✓	320°	15,000	Ø32x80		
T37													
2	9.5W 950LM 830 250681	9,5	68	950	100	3000	F	✗	200°	15,000	Ø38x111		
	9.5W 1050LM 840 250682	9,5	75	1050	111	4000	F		200°	15,000	Ø38x111		

14 AMPOULES LED

Ampoule LED Lucent Classic Lustre



-20~40°C
 CRI80
 3

	#	W	= W	LM	LM/W	K						
P45 E27												
1	2.5W 250LM 827	241590	2,5	25	250	100	2700	F	✗	150°	15,000	Ø45x77
2	5.5W 470LM 822-827	254715	5,5	40	470	86	2200/ 2700	F	✓	240°	25,000	Ø45x85
P45 E14												
3	4.5W 470LM 827	241947	4,5	40	470	104	2700	F	✗	150°	15,000	Ø45x80
	5.5W 470LM 822-827	240936 254716	5,5	40	470	86	2200/ 2700	F	✓	240°	25,000	Ø45x86

14 AMPOULES LED

Ampoule LED Lucent Lustre Filament



-20~40°C

CRI80

3

	#	W	= W	LM	LM/W	K						
P45 E27												
1	1.4W 136LM 827	244558	1,4	15	136	97	2700	F	×	360°	15,000	Ø45x78
2	2.5W 250LM 827	242029	2,5	25	250	100	2700	F	×	360°	15,000	Ø45x78
	241946											
	2.5W 250LM 827	242282							✓	360°		
4	4.1W 350LM 822 Ambrée	240928	4,1	32	350	85	2200	F	✓	320°	15,000	Ø45x82
3	4.5W 470LM 827	242289	4,5	40	470	104	2700	F	×	360°	15,000	Ø45x78
	241950											
	4.5W 470LM 827	241950							✓	360°		
4	4.5W 400LM 822 Ambrée		4,5	40	400	89	2200	F	✓	320°	15,000	Ø45x78
P45 E14												
5	2.5W 250LM 827	242287	2,5	25	250	100	2700	F	×	360°	15,000	Ø45x80
	241589											
	2.5W 250LM 827	241589							✓	360°		
6	4.5W 470LM 827	242288	4,5	40	470	104	2700	F	×	360°	15,000	Ø45x80
	244204											
	4.5W 470LM 827	242032							✓	360°		

14 AMPOULES LED

Ampoule LED Lucent Candle Filament



		#	W	= W	LM	LM/W	K						
B35 E14													
1	2.5 250LM 827	241593	2,5	25	250	100	2700	F	✓	360°	15,000	Ø35x97	
	2.5 250LM 827	241951	2,5	25	250	100	2700	F	✗	360°	15,000	Ø35x97	
2	4.1 350LM 822 Ambrée	240931	4,1	40	350	85	2200	F	✓	320°	15,000	Ø35x97	
	4.5 400LM 822 Ambrée	254643	4,5	40	400	89	2200	F		320°	15,000	Ø35x97	
3	4.5 470LM 827	241592	4,5	40	470	104	2700	F	✗	360°	15,000	Ø35x97	
	4.5 470LM 827	241952	4,5	40	470	104	2700	F	✓	360°	15,000	Ø35x97	
BA35 E14													
4	2.5 250LM 827	241953	2,5	25	250	100	2700	F	✗	360°	15,000	Ø35x123	
5	4.5 400LM 822 Ambrée	254644	4,5	40	400	89	2200	F	✓	320°	15,000	Ø35x123	
6	4.5 470LM 827	241954	4,5	40	470	104	2700	F	✓	360°	15,000	Ø35x123	



AMPOULES LED À DÉCHARGE

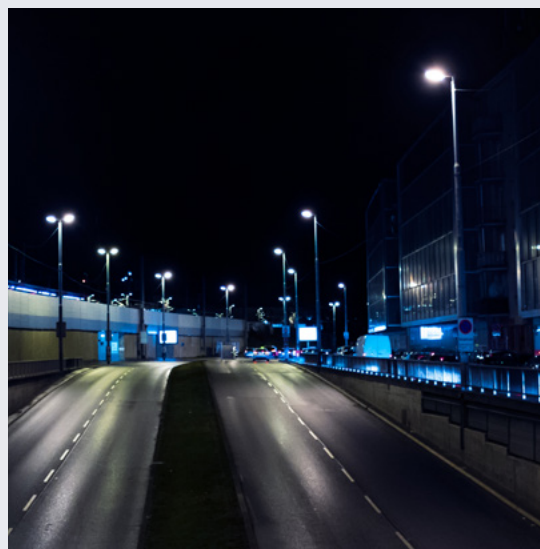

HID



HPL

PUISSANCE	18W - 36W	38W
LUMEN	2800 - 6000	7200 - 7500
LM/W	167	197
IRC	80	70
CULOT	E27 - E40	E40
FORME	HID	HPL
DIMMABLE	×	×
DURÉE DE VIE L70	25,000h	25,000h
GARANTIE	3 ans	3 ans

14 AMPOULES LED

Ampoule LED HID



-20~40°C CRI80 3

	#	W	= W	LM	LM/W	K						
HID E27 En direct 230V												
1	18W 2800LM 830	253952	18	50	2800	156	3000	D	X	330°	25,000	Ø75x180
	18W 3000LM 840	253953	18	50	3000	167	4000	C		330°	25,000	Ø75x180
HID E40 En direct 230V												
2	36W 6000LM 840	253954	36	125	6000	167	4000	C	X	330°	25,000	Ø90x230

14 AMPOULES LED

Ampoule LED HPL



-20~40°C

HPL E40 En direct 230V												
#	W	= W	LM	LM/W	K	Beam angle	Beam spread	Lifetime	Dimensions			
38W 7200LM 730	253950	38	125	7200	189	3000	B	×	330°	25,000	Ø46x207	
38W 7500LM 740	253951	38	125	7500	197	4000	B		330°	25,000	Ø46x207	



PL LED LUCENT



PL-C



PL-S



PL-L

PUISSANCE	3,6W - 7,4W	2,8W - 6W	7,9W - 11,9W
LUMEN	473 - 1000	368 - 805	950 - 1500
LM/W	136	139	126
IRC	80	80	80
CULOT	G24d	G23 - G27	G11
PINS	2	2 & 4	4
BALLAST	En direct 230V	En direct 230V	Électronique
DIMMABLE	×	×	×
DURÉE DE VIE L70	30,000h	30,000h	30,000h
GARANTIE	3 ans	3 ans	3 ans

15 PL LED LUCENT

PL-C LED Lucent | Direct 230V



KEMA
KEUR

-20~40°C

CRI80

3

2 Pins | En direct 230V

1	3.6W 473LM 830 G24d-1 2P	248453	3,6	10	473	131	3000	E	X	120°	30,000	35x35x137
	3.6W 491LM 840 G24d-1 2P	248454	3,6	10	491	136	4000	D		120°	30,000	35x35x137
2	5.2W 650LM 830 G24d-2 2P	248469	5,2	18	650	125	3000	E		120°	30,000	36x36x148
	5.2W 700LM 840 G24d-2 2P	248470	5,2	18	700	134	4000	E		120°	30,000	36x36x148
3	7.4W 950LM 830 G24d-3 2P	248471	7,4	26	950	128	3000	E		120°	30,000	36x36x171
	7.4W 1000LM 840 G24d-3 2P	248472	7,4	26	1000	135	4000	D		120°	30,000	36x36x171

15 PL LED LUCENT

PL-S LED Lucent | Direct 230V



KEMA
KEUR

🌡️ -20~40°C

CRI80

3

💡
#
W
= W
LM
LM/W
K
📄
🔄
🏠
🕒
📏

2 Pins | En direct 230V

			W	= W	LM	LM/W	K					
1	2.8W 368LM 827 G23 2P	248455	2,8	5	368	131	2700	E	X	120°	30,000	21x32x136
	2.8W 368LM 830 G23 2P	248456	2,8	5	368	131	3000	E		120°	30,000	21x32x136
	2.8W 382LM 840 G23 2P	248457	2,8	5	382	136	4000	D		120°	30,000	21x32x136
2	4.3W 540LM 827 G23 2P	248458	4,3	9	540	125	2700	E		120°	30,000	21x32x167
	4.3W 540LM 830 G23 2P	248459	4,3	9	540	125	3000	E		120°	30,000	21x32x167
	4.3W 600LM 840 G23 2P	248460	4,3	9	600	139	4000	D		120°	30,000	21x32x167
3	6W 765LM 827 G23 2P	248464	6	11	765	127	2700	E		120°	30,000	21x32x237
	6W 765LM 830 G23 2P	248465	6	11	765	127	3000	E		120°	30,000	21x32x237
	6W 805LM 840 G23 2P	248468	6	11	805	134	4000	E		120°	30,000	21x32x237

4 Pins | En direct 230V

			W	= W	LM	LM/W	K					
4	4.3W 540LM 827 2G7 4P	248461	4,3	9	540	125	2700	E	X	120°	30,000	21x37x153
	4.3W 540LM 830 2G7 4P	248462	4,3	9	540	125	3000	E		120°	30,000	21x37x153
	4.3W 600LM 840 2G7 4P	248463	4,3	9	600	139	4000	D		120°	30,000	21x37x153
5	6W 765LM 827 2G7 4P	248466	6	11	765	127	2700	E		120°	30,000	21x37x222
	6W 765LM 830 2G7 4P	248467	6	11	765	127	3000	E		120°	30,000	21x37x222

15 PL LED LUCENT

PL-L LED Lucent | Électronique



-20~40°C
 CRI80
 3

W = **W** **LM** **LM/W** **K**

4 Pins | Ballast électronique

1	7.9W 950LM 830	248443	7,9	18	950	120	3000	E	X	160°	30,000	37x23x224
	7.9W 1000LM 840	248444	7,9	18	1000	126	4000	E		160°	30,000	37x23x224
2	11.9W 1450LM 830	248441	11,9	24	1450	122	3000	E		160°	30,000	37x23x319
	11.9W 1500LM 840	248442	11,9	24	1500	126	4000	E		160°	30,000	37x23x319

Veuillez consulter la liste de compatibilité Noxion pour vous assurer de la compatibilité du produit de remplacement.





AMPOULES LED CAPSULE



G9



G4



GY6.35

PUISSANCE	1,9W - 4,8W	0,9W - 2W	2,6W
LUMEN	200 - 600	100 - 200	300
LM/W	125	111	115
IRC	80	80	80
CULOT	G9	G4	GY6.35
DIMMABLE	×	×	×
DURÉE DE VIE L70	15,000h	15,000h	15,000h
GARANTIE	3 ans	3 ans	3 ans

16 AMPOULES LED CAPSULE

Ampoule LED Bolt



		#	W	= W	LM	LM/W	K					
C9												
1	1.9W 200LM 827	241796 254649	1,9	21	200	105	2700	F	×	300°	15,000	ø16x52
2	3.2W 350LM 827	254646	3,2	32	350	109	2700	F	✓	300°	25,000	ø18x59
3	3.8W 470LM 827	241797 254650	3,8	40	470	123	2700	E	×	300°	15,000	ø18x59
	3.8W 470LM 830	241801 254654						E		300°	15,000	ø18x59
4	4.8W 600LM 827	241790 254647	4,8	48	600	125	2700	E		320°	15,000	ø18x59
	4.8W 600LM 830	254648						E		320°	25,000	ø18x59
G4												
5	0.9W 100LM 827	241798 254651	0,9	10	100	90	2700	F	×	320°	15,000	ø12x33
	0.9W 100LM 830	241802 254655						F		320°	15,000	ø12x33
6	1.8W 200LM 827	254652	1,8	21	200	111	2700	F		320°	25,000	ø13x36
	1.8W 200LM 830	254653						F		320°	15,000	ø13x36
7	2W 200LM 827	249469 254683	2	21	200	100	2700	F	✓	320°	15,000	ø15x40
CY6.35												
8	2.6W 300LM 830	249468 254682	2,6	28	300	115	3000	F	×	320°	15,000	ø14x40





TUBES LED



**T8
Standard**



**T8
Extreme HO**



**T8
Extreme UO**



**T8
HF**



**T5
Extreme HF**



**T5
Extreme 230V**

PUISSANCE	7,5W - 19W	9W - 17W	9W - 23W	14W - 20W	16W - 37W	7W - 36W
ÉQUIVALENT	18W - 36W - 58W	18W - 30W - 36W - 58W	18W - 36W - 58W	36W - 58W	28W - 35W - 49W	14W - 54W
LUMEN	900 - 2300	1150 - 2700	1350 - 4100	1950 - 3100	2160 - 3900	1100 - 5600
LM/W	120	160	186	150	150	157
BALLAST	EM/Direct	EM/Direct	EM/Direct	Électronique	Électronique	En direct 230V
DIMMABLE	×	×	×	×	×	×
DURÉE DE VIE L70	50,000h	50,000h	50,000h	50,000h	50,000h	50,000h
GARANTIE	5 ans	5 ans	5 ans	5 ans	5 ans	5 ans

17 TUBES LED

Tube LED T8 Standard | EM / Direct 230V



-10~45°C CRI80 5

	#	W	= W	LM	LM/W	K						
60cm Starter inclus												
1	7.5W 900LM 830	249086	7,5	18	900	120	3000	E	X	180°	50,000	604xø28
	7.5W 900LM 840	249087	7,5	18	900	120	4000	E				
	7.5W 900LM 865	249088	7,5	18	900	120	6500	E				
120cm Starter inclus												
2	15W 1800LM 830	249089	15	36	1800	120	3000	E	X	180°	50,000	1213xø28
	15W 1800LM 840	249090	15	36	1800	120	4000	E				
	15W 1800LM 865	249091	15	36	1800	120	6500	E				
150cm Starter inclus												
3	19W 2300LM 830	249092	19	58	2300	120	3000	E	X	180°	50,000	1514xø28
	19W 2300LM 840	249093	19	58	2300	120	4000	E				
	19W 2300LM 865	249094	19	58	2300	120	6500	E				
4	Starter tube T8 Standard (EM/Direct)	237774										

17 TUBES LED

Tube LED T8 Extreme HO | EM / Direct 230V

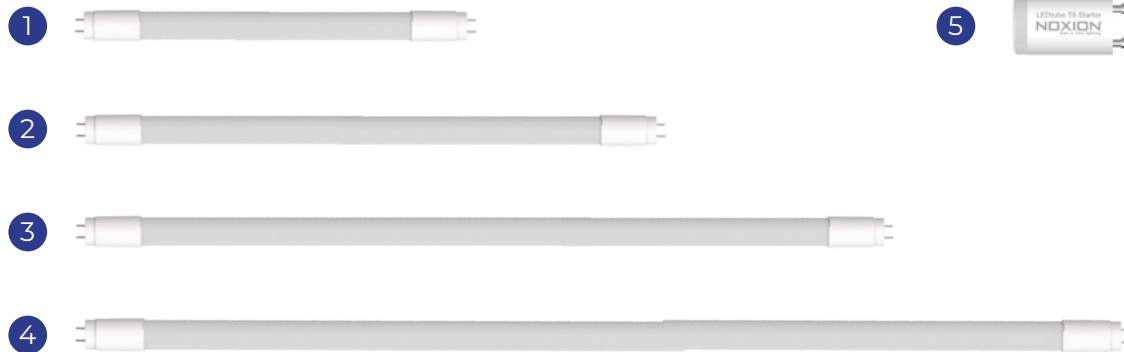

🌡️ -10~45°C

CRI80

5

		#	W	= W	LM	LM/W	K					
60cm Starter inclus												
1	8.2W 1150LM 827	249104	8,2	18	1150	140	2700	D	X	180°	50,000	604xø28
	8.2W 1150LM 830	249105	8,2	18	1150	140	3000	D				
	8.2W 1150LM 840	249106	8,2	18	1150	140	4000	D				
	8.2W 1150LM 865	249107	8,2	18	1150	140	6500	D				
90cm Starter inclus												
2	11.2W 1575LM 830	249108	11,2	30	1575	140	3000	D	X	180°	50,000	908.8xø28
	11.2W 1575LM 840	249109	11,2	30	1575	140	4000	D				
	11.2W 1575LM 865	249110	11,2	30	1575	140	6500	D				
120cm Starter inclus												
3	13W 2100LM 827	249111	13	36	2100	160	2700	C	X	180°	50,000	1213.6xø28
	13W 2100LM 830	249112	13	36	2100	160	3000	C				
	13W 2100LM 840	249113	13	36	2100	160	4000	C				
	13W 2100LM 865	249114	13	36	2100	160	6500	C				
150cm Starter inclus												
4	16.5W 2650LM 830	249116	16,5	58	2650	160	3000	C	X	180°	50,000	1500xø28
	16.5W 2650LM 840	249117	16,5	58	2650	160	4000	C				
	16.5W 2650LM 865	249118	16,5	58	2650	160	6500	C				
5	Starter tube T8 Standard (EM/Direct)	237774										

17 TUBES LED

Tube LED T8 Extreme UO | EM / Direct 230V

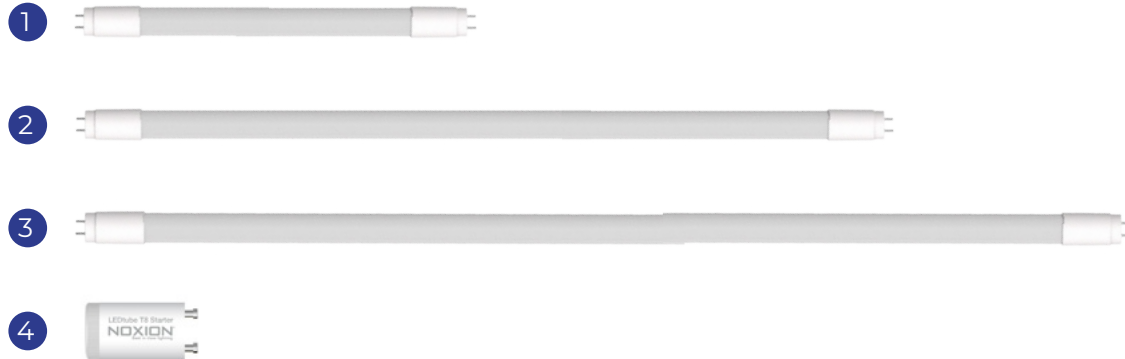

-10~45°C

CRI80

5

	#	W	= W	LM	LM/W	K						
60cm Starter inclus												
1	8.4W 1350LM 830	249095	8,4	18	1350	160	3000	C	X	180°	50,000	604xø28
	8.4W 1350LM 840	249096	8,4	18	1350	160	4000	C				
	8.4W 1350LM 865	249097	8,4	18	1350	160	6500	C				
120cm Starter inclus												
2	15.9W 2550LM 830	249098	15,9	36	2550	160	3000	C	X	180°	50,000	1213xø28
	15.9W 2550LM 840	249099	15,9	36	2550	160	4000	C				
	15.9W 2550LM 865	249100	15,9	36	2550	160	6500	C				
150cm Starter inclus												
3	20.6W 3300LM 830	249101	20,6	58	3300	160	3000	C	X	180°	50,000	1514xø28
	20.6W 3300LM 840	249102	20,6	58	3300	160	4000	C				
	20.6W 3300LM 865	249103	20,6	58	3300	160	6500	C				
	22.1W 4100LM 840	255304	22,1	58	4100	186	4000	B				
	22.1W 4100LM 865	255305	22,1	58	4100	186	6500	B				
	23W 3500LM 830	254043	23	58	3500	152	3000	D				
	23W 3750LM 840	254044	23	58	3750	163	4000	C				
	23W 3750LM 865	254045	23	58	3750	163	6500	C				
4	Starter tube T8 Standard (EM/Direct)	237774										

17 TUBES LED

Tube LED T8 Extreme HO HF | Électronique



-20~45°C

CRI80

5

	#	W	= W	LM	LM/W	K						
120cm												
1	14W 1950LM 830	244316	14	36	1950	140	3000	E	X	190°	50,000	1212.5xø28
	14W 2100LM 840	244317	14	36	2100	150	4000	D				
	14W 2100LM 865	244318	14	36	2100	150	6500	D				
150cm												
2	20W 2800LM 830	244319	20	58	2800	140	3000	E	X	190°	50,000	1513.1xø28
	20W 3100LM 840	244320	20	58	3100	150	4000	D				
	20W 3100LM 865	244321	20	58	3100	150	6500	D				

Veillez consulter la liste de compatibilité Noxion pour vous assurer de la compatibilité du produit de remplacement.

17 TUBES LED

Tube LED T5 Extreme HE / HO HF | Électronique



-20~45°C
 CRI80
 5

		#	W	= W	LM	LM/W	K					
55cm												
1	7.5W 1050LM 830	255468	7,5	14	1050	140	3000	E	X	≤180°	60,000	563xø18
	7.5W 1100Lm 840	255469	7,5	14	1100	146	4000	E				
115cm												
2	16W 2160LM 830	245197	16	28	2160	135	3000	E	X	≤180°	50,000	1163xø18
	16W 2400LM 840	245198	16	28	2400	150	4000	D				
	16W 2400LM 865	245199	16	28	2400	150	6500	D				
	26W 3700LM 830	255470	26	54	3700	142	3000	E				
	26W 3900LM 840	255471	26	54	3900	150	4000	D				
60,000												
145cm												
3	19W 2610LM 830	249042	19	35	2610	113	3000	E	X	≤180°	50,000	1463xø18
	19W 2900LM 830	249043	19	35	2900	152	4000	D				
	19W 2900LM 830	249044	19	35	2900	152	6500	D				
	26W 3510LM 830	245200	26	49	3510	135	3000	E				
	26W 3900LM 840	245201	26	49	3900	150	4000	D				
	26W 3900LM 865	245202	26	49	3900	150	6500	D				
	37W 5600LM 840	255472	37	80	5600	150	4000	D				
60,000												

Veuillez consulter la liste de compatibilité Noxion pour vous assurer de la compatibilité du produit de remplacement.

17 TUBES LED

Tube LED T5 Extreme HE / HO | En direct 230V

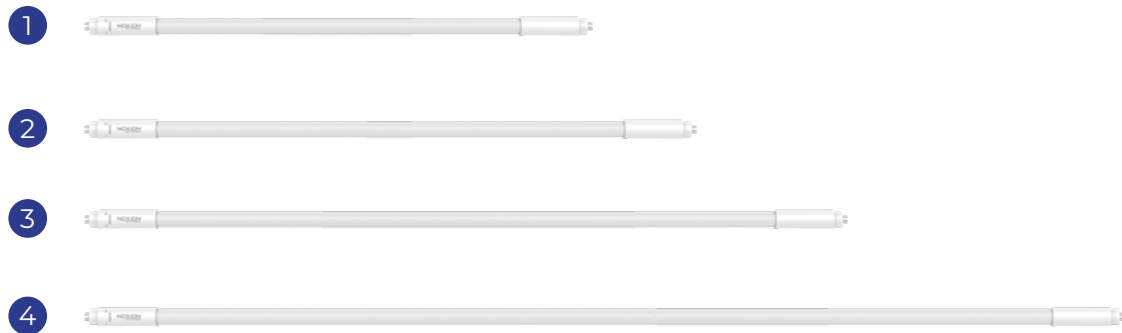

-20~45°C
 CRI80
 5

		#	W	= W	LM	LM/W	K						
55cm													
1	7W 1100LM 840	255473	7	14	1100	157	4000	D	×	≤180°	50,000	549xø19	
85cm													
2	18W 2800LM 840	255474	18	39	2800	150	4000	D	×	≤180°	50,000	849xø19	
115cm													
3	16W 2300LM 830	255475	16	28	2300	143	3000	D	×	≤180°	50,000	1149xø19	
	16W 2400LM 840	255476	16	28	2400	150	4000	D					
	26W 3640LM 830	247466	26	54	3640	140	3000	D					
	26W 3900LM 840	246504	26	54	3900	150	4000	D					
	26W 3900LM 865	246505	26	54	3900	150	6500	D					
145cm													
4	26W 3640LM 830	246506 247467	26	49	3640	140	3000	D	×	≤180°	50,000	1449xø19	
	26W 3900LM 840	246507	26	49	3900	150	4000	D					
	26W 3900LM 865	246508	26	49	3900	150	6500	D					
	36W 5600LM 840	255477	36	49	5600	155	4000	D					



NOXION

LED Dimmer

Automatic

30V-20Hz
R1-0-200W RC-0-300W LED

nIM

CE

ACCESSOIRES LED

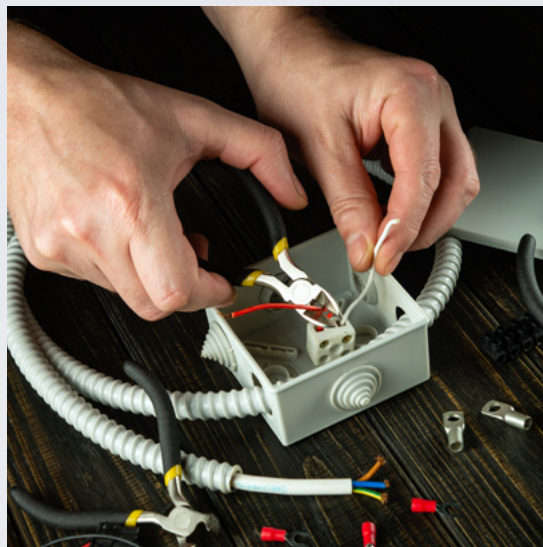

18 ACCESSOIRES LED

Variateur LED



1



2



3





4

3

		#	300W/VA	0W/VA	DM	LED	HL	INC
1	Dimmer LED Automatic Switch RLC 0-300W 220-240V	238453	300W/VA	0W/VA	Auto Leading/ Trailing Edge	RC:0-300W RL:0-200W	10-300W/VA	10-300W/VA
	Dimmer LED Automatic Switch RC 0-150W 230V	248985	150W/VA	0W/VA	Trailing Edge	RC:0-150W	10-300W/VA	10-300W/VA
2	Interrupteur Switch RLC 0-50W 220-240V	238539	50W/VA	0W/VA	Auto Leading/ Trailing Edge	RLC:0-50W	0-100W/VA	0-100W/VA
	Interrupteur							
3	Interrupteur - Soft edge Blanc	238540						
4	Interrupteur - Hard edge Blanc	238541						

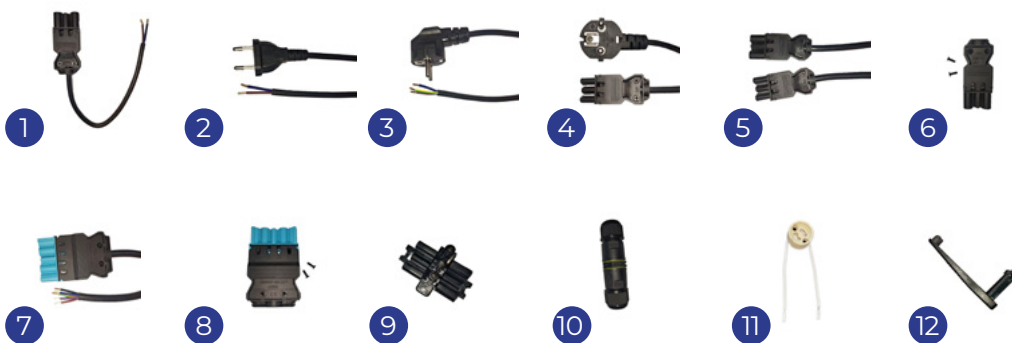
Cables & Autres



	#	
1	Cable Noir - Male + Open Ends - 0,3m - 2 pole	252483
	Cable Noir - Male + Open Ends - 0,3m - 3 pole	252484
	Cable Noir - Male + Open Ends - 2m - 3 pole	252485
	Cable Noir - Male + Open Ends - 3m - 3 pole	252486
2	Cable Blanc - C7 Europlug + Open Ends - 2m - 2 pole	252509
	Cable Noir - C7 Europlug + Open Ends - 2m - 2 pole	252510
3	Câble - Shuko Europlug to Open Ends - Noir 2m - 3 pole	252506
	Câble - Shuko Europlug to Open Ends - Noir 3m - 3 pole	252507
	Câble - Shuko Europlug to Open Ends - Noir 5m - 3 pole	252508
4	Câble - Female to Shuko Europlug - Noir 2m - 3 pole	252489
	Câble - Female to Shuko Europlug - Noir 3m - 3 pole	252490
5	Cable - Male to Female - Noir 1m - 3 pole	252477
	Cable - Male to Female - Noir 1,5m - 3 pole	252478
	Cable - Male to Female - Noir 2m - 3 pole	252479
	Cable - Male to Female - Noir 3m - 3 pole	252480
	Cable - Male to Female - Noir 5m - 3 pole	252481
6	Cable - Male to Female - Bleu 3m - 5 pole	252504
	Connecteur - Male - Noir 3 pole	252492
7	Cable Noir - Male + Open Ends - 0,3m - 5 pole	252498
	Cable Noir - Male + Open Ends - 2m - 5 pole	252499
8	Connecteur - Male - Bleu 5 pole	252496
	Connecteur - Female - Bleu 5 pole	252497
9	Connecteur - 1 Male + 2 Female - Noir 3 pole	252482
	Connecteur - 1 Male + 2 Female - Noir 5 pole	252494
	Connecteur - 1 Male + 5 Female - Noir 3 pole	252493
10	Connecteur étanche Quick Cable - Noir 3 pole	252512
	Connecteur étanche Quick T - Noir 3 pole	252513
11	Douille GU10 universel - Blanc 0,1m - 2 pole	252511
12	Déchargeur De Tension Noir	252495
	Boite déchargeur De Tension - Noir - 3 pole	252514

VOS AVANTAGES EN TANT QUE PROFESSIONNEL

En tant que professionnel, nous vous offrons des avantages exclusifs destinés à faciliter votre travail d'installateur et à accélérer la réalisation de vos projets d'éclairage. Bénéficiez de l'aide de nos experts en éclairage, d'un accès direct avec votre chargé d'affaires et bien plus encore ! Les services que nous proposons sont destinés à vous faire économiser du temps, de l'argent, et à vous apporter le soutien dont vous avez réellement besoin.

Développement de produits Noxion

Nous ne nous contentons pas de proposer des produits de qualité. En fonction de la quantité dont vous avez besoin, nous pouvons collaborer avec vous pour créer des solutions d'éclairage personnalisées qui répondent à vos besoins. Nous pouvons développer des produits sur mesure qui répondent à vos exigences spécifiques ou à celles de vos clients. Nos experts sont à votre disposition pour créer des solutions qui correspondent à vos exigences techniques. Ces éclairages seront fabriqués en interne dans nos usines. Vous pouvez ainsi offrir à vos clients des solutions d'éclairage sur mesure qui vous différencient de la concurrence.

Avec notre engagement envers l'innovation, nous vous accompagnons pour atteindre des résultats exceptionnels à chaque projet. Construisons ensemble quelque chose de grand !



Demande d'échantillon

Si vous êtes intéressé par un produit spécifique et que vous voulez voir s'il correspond à vos besoins, à vos exigences et à votre projet, alors vous pouvez faire une demande d'échantillon.

Ainsi vous pouvez tester la qualité, la fonctionnalité et la compatibilité du produit avec votre projet avant de vous engager. C'est totalement gratuit ! Cela vous permet de minimiser les risques et de consolider votre choix d'achat. De plus, avec à la manipulation du produit, vous pouvez fournir de meilleures recommandations à vos clients. Il vous suffit de contacter votre chargé(e) d'affaire attribué(e) et il/elle s'occupera du reste !

Un accompagnement de A à Z

Si vous n'êtes pas sûr de l'éclairage qui convient le mieux à votre projet, vous pouvez compter sur nous. Nos experts en éclairage se chargent de tout : calculs d'éclairage, plans techniques ou encore devis détaillés. Que votre projet implique des conceptions complexes ou des questions de compatibilité entre les produits, nous sommes là pour simplifier votre travail. Nous sommes réactifs aux demandes pour que vos projets avancent rapidement.

Bon de livraison neutre

Nous comprenons les besoins des installateurs, c'est pourquoi nous proposons des bons de livraison neutres pour vos commandes et livrer directement sur le chantier. Voici les avantages pour votre entreprise :

- **Image professionnelle** : Les bons de livraison neutres vous permettent de livrer directement aux clients sans mentionner notre entreprise, vous laissant ainsi maîtriser la relation client.
- **Confiance du client** : Une documentation neutre met en valeur votre rôle d'expert et de fournisseur, renforçant la confiance de vos clients dans vos services.
- **Logistique simplifiée** : Évitez le stockage inutile en expédiant directement les produits à vos clients, tout en garantissant une livraison rapide.

Votre chargé(e) d'affaires attitré(e)

Lorsque vous devenez notre partenaire, vous bénéficiez du suivi de votre chargé(e) d'affaires attitré(e), qui est à vos côtés pour vous apporter un soutien rapide, personnalisé et fiable à chaque étape de vos projets. Avoir un(e) chargé(e) d'affaires dédié(e) est un réel atout pour économiser du temps. Il ou elle apprendra à connaître vos habitudes de travail, vos habitudes d'achat, votre fonctionnement et vos contraintes au fil du temps.

Votre chargé(e) d'affaires veillera à ce que toutes vos questions reçoivent une réponse à la vitesse de la lumière, garantissant ainsi votre satisfaction et celle de vos clients !



LISTE DES SYMBOLES

	Modèle		Urgence 3h		Option angle de diffusion
	N° Réf.		Durée de charge		Détecteur PIR
	EAN		Batterie		Dimmable 0-10V
	Wattage		Taille de coupe		Matériel - GRP
	Équivalent		Inclinaison		Switch de puissance
	Lumen		Montage encastré		Nouveau produit
	Efficacité		Montage en surface		Multi-CCT
	Kelvin		Label énergétique		
	Dimmable		Charge Max.		
	Angle diffusion		Charge Min.		
	Durée de vie (h)		Charge Max/Min		
	Taille (mm)		Type de charge		
	Garantie (ans)		Mode dimmable		
	Indice de rendu des couleurs		Éclairage LED		
	Indice de protection contre les impacts		Tous types d'éclairage		
	Indice de protection d'étanchéité		Mode contrôle		
	Options Oui / Non		Plage de puissance		
	Taille du schéma		Section câble		
	Température ambiante de fonctionnement		Marque du driver		
	Schéma photométrique		DALI		
	Câblage traversant 5x		Détecteur du jour		
	Câblage traversant 2x		Détecteur de mouvement		
	Options disponibles				

www.noxion.com info@noxion.com

PICPAC B.V. Hooge Zijde 30
5626 DC Eindhoven, The Netherlands
+31 (0)85 - 303 29 82

21 rue Ferdinand Buisson
53810 Changé, France
+33(0)2 52 86 00 01

2026

NOXION[®]
Best in class lighting

©2026 PICPAC B.V. – Tous droits réservés. Les données sont susceptibles d'être modifiées sans préavis. Noxion se réserve le droit de modifier les spécifications des produits sans préavis ni obligation et n'assume aucune responsabilité quant aux conséquences de l'utilisation de ce document. Sous réserve d'erreurs et de fautes d'impression.